



# Intel® Server System M70KLP Family

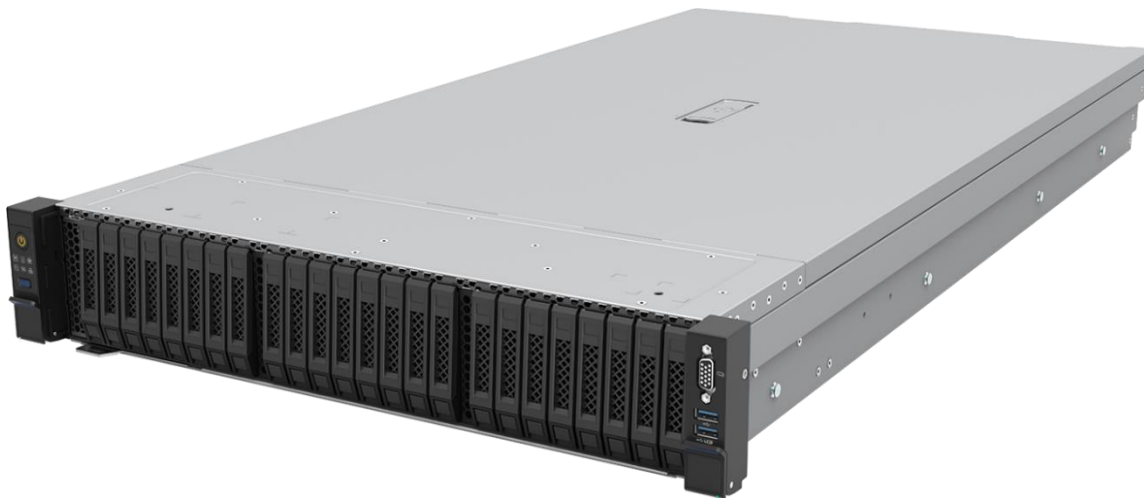
## *Service Guide*

A guide providing instructions for the installation and removal of serviceable system components, configuration options, and available Intel accessories

Rev 1.0

March 2021

# M70KLP



Delivering Breakthrough Datacenter System Innovation – Experience What's Inside!

<Blank page>

## ***Document Revision History***

Date	Revision	Changes
March 2021	1.0	1 <sup>st</sup> Production Release

## ***Disclaimers***

Intel technologies' features and benefits depend on system configuration and may require enabled hardware, software, or service activation. Performance varies depending on system configuration. No computer system can be secure. Check with your system manufacturer or retailer or learn more at intel.com.

You may not use or facilitate the use of this document in connection with any infringement or other legal analysis concerning Intel products described herein. You agree to grant Intel a non-exclusive, royalty-free license to any patent claim thereafter drafted which includes subject matter disclosed herein.

No license (express or implied, by estoppel or otherwise) to any intellectual property rights is granted by this document.

The products described may contain design defects or errors known as errata which may cause the product to deviate from published specifications. Current characterized errata are available on request.

Intel disclaims all express and implied warranties, including without limitation, the implied warranties of merchantability, fitness for a particular purpose, and non-infringement, as well as any warranty arising from course of performance, course of dealing, or usage in trade.

This document contains information on products, services and/or processes in development. All information provided here is subject to change without notice. Contact your Intel representative to obtain the latest Intel product specifications.

Copies of documents which have an order number and are referenced in this document may be obtained by calling 1-800-548-4725 or by visiting [www.intel.com/design/literature.htm](http://www.intel.com/design/literature.htm).

Intel, the Intel logo, Xeon, and Intel Optane are trademarks of Intel Corporation or its subsidiaries in the U.S. and/or other countries.

\*Other names and brands may be claimed as the property of others.

© Intel Corporation



## Safety Warnings

**Heed safety instructions:** Before working with your server product, whether you are using this guide or any other resource as a reference, pay close attention to the safety instructions. You must adhere to the assembly instructions in this guide to ensure and maintain compliance with existing product certifications and approvals. Use only the described, regulated components specified in this guide. Use of other products/components will void the UL listing and other regulatory approvals of the product and will most likely result in noncompliance with product regulations in one or more regions in which the product is sold.

**System power on/off:** The power button DOES NOT turn off the system AC power. To remove power from the system, you must unplug the AC power cord. Make sure the AC power cord is unplugged before you open the chassis, add, or remove any components.

**Hazardous conditions, devices and cables:** Hazardous electrical conditions may be present on power, telephone, and communication cables. Turn off the server and disconnect the power cord, telecommunications systems, networks, and modems attached to the server before opening it. Otherwise, personal injury or equipment damage can result.

**Installing or removing jumpers:** A jumper is a small plastic encased conductor that slips over two jumper pins. Some jumpers have a small tab on top that you can grip with your fingertips or with a pair of fine needle nosed pliers. If your jumpers do not have such a tab, take care when using needle nosed pliers to remove or install a jumper; grip the narrow sides of the jumper with the pliers, never the wide sides. Gripping the wide sides can damage the contacts inside the jumper, causing intermittent problems with the function controlled by that jumper. Take care to grip with, but not squeeze, the pliers or other tool you use to remove a jumper, or you may bend or break the pins on the board.

### Electrostatic Discharge (ESD)

Electrostatic discharge can damage the computer or the components within it. ESD can occur without the user feeling a shock while working inside the system chassis or while improperly handling electronic devices like processors, memory or other storage devices, and add-in cards.



Intel recommends the following steps be taken when performing any procedures described within this document or while performing service to any computer system.

- Where available, all system integration and/or service should be performed at a properly equipped ESD workstation
- Wear ESD protective gear like a grounded antistatic wrist strap, sole grounders, and/or conductive shoes
- Wear an anti-static smock or gown to cover any clothing that may generate an electrostatic charge
- Remove all jewelry
- Disconnect all power cables and cords attached to the server before performing any integration or service
- Touch any unpainted metal surface of the chassis before performing any integration or service
- Hold all circuit boards and other electronic components by their edges only
- After removing electronic devices from the system or from their protective packaging, place them component side up on to a grounded anti-static surface or conductive workbench pad. Do not place electronic devices on to the outside of any protective packaging.

**Caution:** Slide / Rail mounted equipment is not to be used as a shelf or a workspace



Intel warrants that this product will perform to its published specifications. However, all computer systems are inherently subject to unpredictable system behavior under various environmental and other conditions.

This product is not intended to be the sole source for any critical data and the user must maintain a verified backup. Failure to do so or to comply with other user notices in the product user guide and specification documents may result in loss of or access to data.

**Weight of the system:**

- Due to the weight of a system, Intel recommends carrying the system with two people supporting the system from the sides or using a mechanical lift or a cart when moving the system from one location to another.
- If your system has rack handles installed, do not lift or carry the system by the rack handles
- When lifting or moving a chassis, always grasp it by all four corners. Do not grasp the chassis by two points at opposing diagonal corners, doing so may damage the internal components.
- If you can only grasp the chassis at two different points, always grasp the chassis by the sides at the midpoint.

# Table of Contents

<b>1. Introduction</b>	<b>11</b>
1.1 About This Document	12
<b>2. System Access and Cable Routing</b>	<b>13</b>
2.1 System Top Cover and Air Duct – Removal	13
2.1.1 System Top Cover Removal	13
2.1.2 Air Duct Removal	14
2.2 System Air Duct and Top Cover – Installation	16
2.2.1 Air Duct Installation	16
2.2.2 System Top Cover Installation	19
2.3 Cable Routing	21
2.3.1 Cable Management Brackets	22
2.3.2 System Fan Housing – Removal / Installation	22
<b>3. System Options and Accessories</b>	<b>27</b>
3.1 Rail Kit Installation	28
3.2 Add-in Card Installation and Removal	32
3.2.1 PCIe* Add-in Card Installation - Server Board Add-in slots	32
3.2.2 PCIe* Add-in Card Removal - Server Board Add-in slots	33
3.2.3 PCIe* Add-in Card Installation – Riser Cards	34
3.2.4 PCIe* Add-in Card Removal – Riser Card	37
3.3 Front 2.5” Drive Installation	41
3.4 DDR4 DIMM / Intel® Optane™ PMem Installation	43
3.5 Network Adapter for OCP* 3.0 (Small Form Factor) – Installation / Removal	44
3.5.1 Network Adapter for OCP* 3.0 (Small Form Factor) Installation	45
3.5.2 Network Adapter for OCP* 3.0 (Small Form Factor) Removal	46
3.6 M.2 Storage Device Installation / Removal	47
3.6.1 M.2 SSD Installation	47
3.6.2 M.2 SSD Removal	48
3.7 Intel® RAID Maintenance Free Backup Unit (RMFBU) Installation / Removal	48
3.7.1 RMFBU Installation	49
3.7.2 RMFBU Removal	50
<b>4. System Features Overview</b>	<b>51</b>
<b>5. FRU Replacement</b>	<b>59</b>
5.1 System Fan Replacement	60
5.2 DIMM / Intel® Optane™ PMem Replacement	62
5.3 System Battery Replacement	63
5.4 Power Supply Module Replacement	64
5.5 Front 2.5” Drive Replacement	65
5.5.1 Drive Removal	66
5.5.2 Drive Replacement	67
5.6 Intel® VROC 7.5 Key Replacement	68

5.6.1	Intel® VROC 7.5 (VMD NVMe* RAID) Key Removal .....	68
5.6.2	Intel® VROC 7.5 (VMD NVMe* RAID) Key Installation .....	69
5.7	Backplane Replacement.....	70
5.7.1	Backplane Removal.....	70
5.7.2	Backplane Installation.....	71
5.8	Power Distribution Board (PDB) Replacement.....	72
5.8.1	Power Distribution Board (PDB) Removal.....	72
5.8.2	Power Distribution Board (PDB) Installation.....	73
5.9	Processor Replacement.....	73
5.9.1	Processor Heat Sink Module (PHM) Removal .....	74
5.9.2	PHM Disassembly.....	75
5.9.3	PHM Reassembly.....	76
5.9.4	PHM Installation .....	79
5.10	Server Board Replacement .....	81
5.10.1	Server Disassembly.....	81
5.10.2	Server Board Removal .....	82
5.10.3	Server Board Installation .....	83
5.10.4	System Reassembly .....	84
<b>Appendix A.</b>	<b>Getting Help .....</b>	<b>85</b>
<b>Appendix B.</b>	<b>Memory Population Rules.....</b>	<b>86</b>
<b>Appendix C.</b>	<b>Product Safety – Multi-Language.....</b>	<b>90</b>
<b>Appendix D.</b>	<b>Glossary .....</b>	<b>106</b>

## List of Figures

Figure 1. Intel® Server System M70KLP (Standard System Option) .....	11
Figure 2. System Top Cover Removal.....	14
Figure 3. Chassis Intrusion Switch Cable Connection on Server Board .....	14
Figure 4. Air Duct Lock Bar Removal.....	15
Figure 5. M.2 SSD Interface Cable Connection on Server Board .....	15
Figure 6. Air Duct Removal.....	16
Figure 7. Cable Management Brackets.....	16
Figure 8. Air Duct Placement.....	17
Figure 9. M.2 SSD Interface Cable Installation to Server Board .....	17
Figure 10. Air Duct Lock Bar Orientation.....	18
Figure 11. Air Duct Lock Bar Installation .....	18
Figure 12. Chassis Intrusion Switch Cable to Server Board .....	19
Figure 13. Open Top Cover Latch .....	19
Figure 14. Top Cover Placement .....	20
Figure 15. Top Cover Latch Lock.....	20
Figure 16. Cable Routing Channels.....	21
Figure 17. Internal Cable Management.....	22
Figure 18. System Fan Removal.....	22
Figure 19. System Fan Housing Removal.....	23
Figure 20. Fan Housing Mounting Bracket Removal .....	23
Figure 21. Fan Housing Mounting Bracket Installation .....	24
Figure 22. System Fan Housing – Open Latches to Install.....	24
Figure 23. System Fan Housing Placement.....	25
Figure 24. System Fan Housing – Close Latches.....	25
Figure 25. System Fan Placement Orientation Features .....	26
Figure 26. System Fan Installation.....	26
Figure 27. System Features Identification .....	27
Figure 28. Rail Kit - Inner Rail Removal.....	28
Figure 29. Rail Kit – Re-position Middle Rail.....	29
Figure 30. Rail Kit - Inner Rail Attachment to Chassis.....	29
Figure 31. Rail Kit - Rail Installation to Mounting Posts.....	30
Figure 32. Rail Kit - Server Installation into Rails.....	31
Figure 33. Add-in Card to Server Board - Filler Plate Removal .....	32
Figure 34. Add-in Card to Server Board - Card Installation .....	32
Figure 35. Add-in Card removal from Server Board.....	33
Figure 36. Riser Card Assembly Removal .....	35
Figure 37. Riser Card - Filler Plate Removal.....	35
Figure 38. Riser Card - Add-in Card Installation .....	36
Figure 39. Riser Card - Close Filler Plate Retention Cover.....	36
Figure 40. Riser Card - Auxiliary PCIe* Cable Connection.....	36

Figure 41. Riser Card Installation into System ..... 37

Figure 42. Riser Card Assembly Removal ..... 38

Figure 43. Add-in Card Removal from Riser Assembly ..... 39

Figure 44. Riser Card - Auxiliary PCIe\* Cable Connection ..... 40

Figure 45. Riser Card Installation into System ..... 40

Figure 46. Front Drive Bay Drive Carrier Removal ..... 41

Figure 47. Drive Blank Removal ..... 41

Figure 48. 2.5" Drive Installation to Drive Carrier ..... 42

Figure 49. Installation of Drive Assembly to Front Drive Bay ..... 42

Figure 50. DIMM Blank Removal ..... 43

Figure 51. Memory Module Installation ..... 44

Figure 52. OCP\* Card Bay Insert Removal ..... 45

Figure 53. OCP\* Card with Pull-tab Installation ..... 45

Figure 54. OCP\* Card with Pull-tab Removal ..... 46

Figure 55. OCP\* Bay Insert Installation ..... 46

Figure 56. M.2 SSD Interface Board ..... 47

Figure 57. M.2 SSD Installation ..... 47

Figure 58. M.2 SSD Removal ..... 48

Figure 59. Intel® RMFBU Placement ..... 48

Figure 60. Intel® RMFBU Accessory Kit ..... 49

Figure 61. Intel® RMFBU Placement ..... 49

Figure 62. Intel® RMFBU Removal ..... 50

Figure 63. Common System Features Overview ..... 51

Figure 64. 8 x2.5" SSD Front Drive Bay Configuration ..... 53

Figure 65. 16 x2.5" SSD Front Drive Bay Configuration ..... 53

Figure 66. 24 x2.5" SSD Front Drive Bay Configuration ..... 53

Figure 67. Front Control and I/O Panels ..... 54

Figure 68. 2.5" Hot Swap Drive LED Identification ..... 55

Figure 69. Air Duct Options ..... 55

Figure 70. Standard System - Back Panel Features ..... 56

Figure 71. GPU Enabled System – Back Panel Features ..... 56

Figure 72. 2000W Power Supply Module ..... 57

Figure 73. Server Board Features ..... 58

Figure 74. Individual Fan Removal or Installation ..... 60

Figure 75. System Fan ..... 61

Figure 76. System Fan Placement ..... 61

Figure 77. Memory Module Removal ..... 62

Figure 78. DIMM Installation ..... 62

Figure 79. System Battery Removal ..... 63

Figure 80. System Battery Installation ..... 64

Figure 81. Power Supply Module Extraction ..... 64

Figure 82. Power Supply Module Installation ..... 65

Figure 83. Front Drive Bay - Drive Extraction .....	66
Figure 84. 2.5" Drive Removal from Drive Carrier.....	66
Figure 85. Drive Blank Installation to Drive Carrier.....	67
Figure 86. 2.5" SSD Installation to Drive Carrier .....	67
Figure 87. Drive Assembly Installation to Front Drive Bay .....	68
Figure 88. Intel® VROC Key Removal .....	68
Figure 89. Intel® VROC Key Installation .....	69
Figure 90. Backplane Removal .....	70
Figure 91. Backplane Installation .....	71
Figure 92. Power Distribution Board Removal.....	72
Figure 93. Power Distribution Board Installation.....	73
Figure 94. Processor Heat Sink Handling.....	74
Figure 95. PHM Assembly Removal from Processor Socket.....	74
Figure 96. Processor Socket Cover Installation.....	75
Figure 97. Processor Removal from PHM Assembly.....	75
Figure 98. Processor Carrier Clip Removal from PHM Assembly.....	76
Figure 99. Installing Processor Carrier Clip onto Processor – Part 1.....	76
Figure 100. Installing Processor Carrier Clip onto Processor – Part 2.....	77
Figure 101. Processor Heat Sink Handling.....	77
Figure 102. Processor Heat Sink Anti-tilt Wires in the Outward Position.....	78
Figure 103. Pin 1 Indicator of Processor Carrier Clip.....	78
Figure 104. Processor Socket Cover Removal.....	79
Figure 105. PHM Alignment with Processor Socket Assembly.....	79
Figure 106. PHM Installation onto Server Board .....	80
Figure 107. Tighten Heat Sink Fasteners .....	80
Figure 108. Server Board Removal .....	82
Figure 109. Server Board Installation .....	83
Figure 110. DIMM Slot Layout .....	86

## List of Tables

Table 1. Product Reference Documentation and Support Collaterals .....	11
Table 2. System Features Table .....	51
Table 3. Front Panel Button and LED Operation .....	54
Table 4. DDR4 DIMM Attributes Table for “Identical” and “Like” DIMMs .....	87

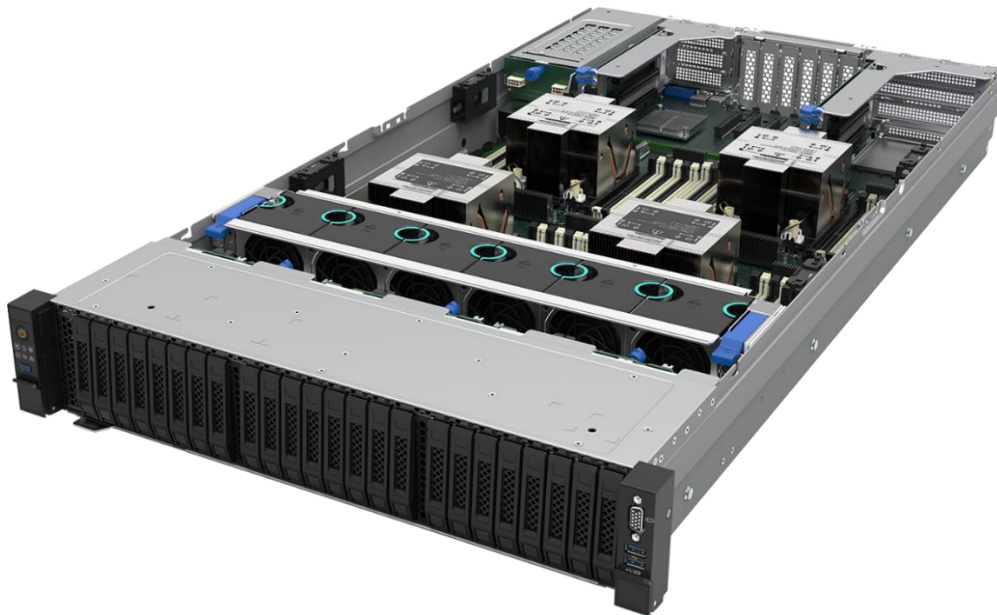


# 1. Introduction

The Intel® Server System M70KLP is a purpose-built system that delivers power and performance at a peak efficiency in a 2U rack mount server form factor. It features the 3rd Gen Intel® Xeon® Scalable processor family in a four-socket configuration, delivering high core count and new hardware-enhanced security features. Previous generation Intel® Xeon® processor and Intel® Xeon® Scalable processor families are not supported.

With support for up to 48 DDR4 DIMMs, the system provides high memory bandwidth for memory intensive workloads. Increase the amount of memory or add memory persistence by adding high capacity Intel® Optane™ persistent memory 200 series modules.

Flexible I/O capabilities include support for optional high-speed networking using Intel network adapters for OCP 3.0 (small form factor); up to twenty-four (24) 2.5" hot swap capable front drive bays; and up to ten (10) PCI Express (PCIe\*) add-in cards with optional riser card options. Slim-PCIe connectors on the server board add additional flexibility by providing the option to increase the number of PCIe add-in cards to twelve (12) and/or provide NVMe\* SSD support to the front drive bays.



**Figure 1. Intel® Server System M70KLP (Standard System Option)**

For additional information, refer to the product documents and other product support collaterals specified in the following table:

**Table 1. Product Reference Documentation and Support Collaterals**

Topic	Document Title or Support Collateral	Document Classification
For system integration instructions and service guidance	Intel® Server System M70KLP Family Service Guide	Public
For server configuration guidance and compatibility	Intel® Server System M70KLP Family Configuration Guide	Public
For in-depth technical information about this family	Intel® Server System M70KLP Family Technical Product Specification (TPS)	Public
For information on the integrated BIOS Setup Utility	Intel® Server System M70KLP Family BIOS Setup User Guide	Public (Pending)

Topic	Document Title or Support Collateral	Document Classification
For information on the Integrated BMC Web Console	Intel® Server System M70KLP Product Family Integrated BMC Web Console User Guide	Public (Pending)
For technical information for Intel® Optane™ Persistent Memory 200	Intel® Optane™ Persistent Memory 200 Series Operations Guide	Intel Confidential
For setup information for Intel® Optane™ Persistent Memory 200	Intel® Optane™ Persistent Memory Startup Guide	Public
For latest system software updates: BIOS and Firmware	System Update Package (SUP)**	Public
To obtain full system information	Intel® SYSINFO Utility – Various OS support**	Public
Configure, Save and Restore various system options	Intel® SYSCFG Utility – Various OS support**	Public
To configure and manage Intel® RAID Controllers	Intel® RAID Web Console 2 Utility – Various OS support**	Public

\*\* Go to following Intel website to download the latest system software updates, utility software, and drivers for onboard devices: <http://downloadcenter.intel.com/>

To download the latest product documentation, go to:  
<https://www.intel.com/content/www/us/en/support/products/77593/server-products/server-systems.html>.

## 1.1 About This Document

This document provides system integrators and service technicians with instructions for the installation and extraction of serviceable system components, configuration options, and available Intel accessories. The document is organized as follows:

**Chapter 1 – Introduction** – Overview of document structure and identification of available reference documents for the specified server product family and supporting Intel technologies.

**Chapter 2 – System Access and Cable Routing** – This chapter should be referenced before attempting most of the procedures described in this document. It provides instructions for the removal and installation of the system top cover and system air duct. It also communicates cable routing requirements and recommendations.

**Chapter 3 – System Options and Accessories** – This chapter provides detailed instructions necessary to enhance system configurations by installing additional components and/or available accessory kits.

**Chapter 4 - System Features Overview** – This chapter, along with Chapter 5, focuses on system service, providing field technicians and service personnel with an overview of the server system. This chapter identifies the location of system features and configurable options.

**Chapter 5 – FRU Replacement** – This chapter provides detailed instructions necessary to replace system components identified as field replaceable.

**Appendix A – Getting Help.** Provides server system support and contact information.

**Appendix B –Memory Population Rules.** Summary of memory population rules.

**Appendix C – Product Safety – Multi-language**

## 2. System Access and Cable Routing

Most procedures documented in the following chapters will require access to the inside of the system. This chapter provides step-by-step instructions for the removal and reinstallation of both the system top cover and the system air duct.

In addition, as this server family can support many different system configurations where several internal cables may be necessary, this chapter will provide guidance for best cable routing using features designed into the chassis.

### Before You Begin

Before integration of any system components, review all the safety and ESD precautions found in the Safety Warnings section at the beginning of this document.

### System Reference

In the following procedures, all references to left, right, front, top, and bottom assume the reader is facing the front of the server chassis.

### Instruction Format

Each procedure described in this chapter follows an illustration first format. This format gives the reader the option to follow a quicker path to completing the objective by first seeing an illustration of the intended procedural step or steps. If necessary, the reader can follow the step-by-step instructions that follow each illustration.

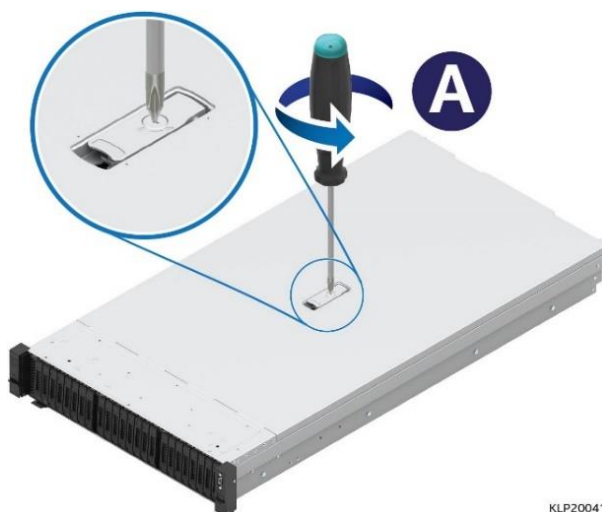
## 2.1 System Top Cover and Air Duct – Removal

### Required Tools and Supplies

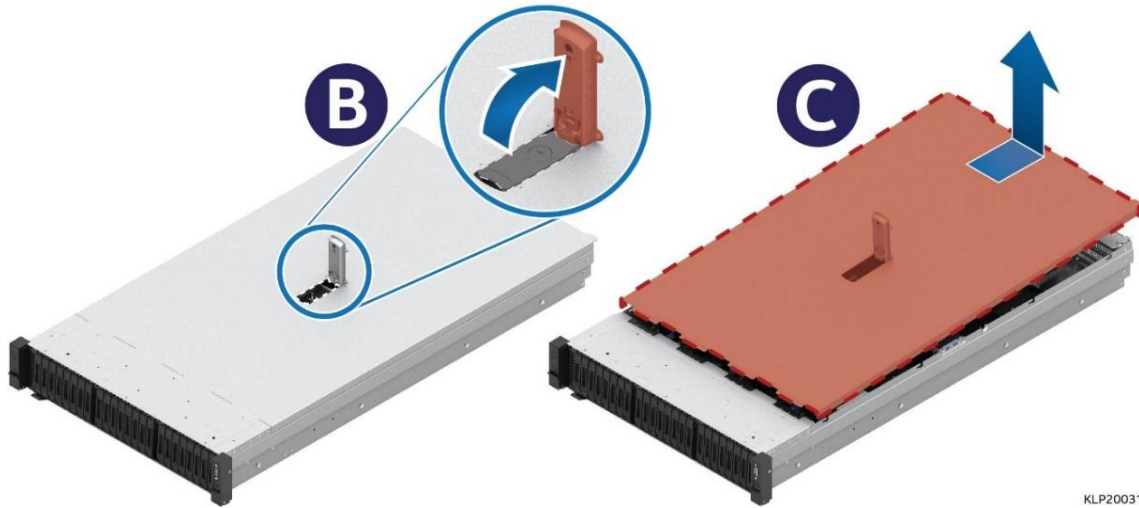
- Anti-static wrist strap and conductive workbench pad (recommended)
- Phillips\* (cross head) screwdriver #1

### 2.1.1 System Top Cover Removal

Before removing the top cover, power down the system and unplug all power cables. The only exception to this requirement is when hot swapping a failed system fan. See [Section 5.1](#) for fan replacement information.



KLP20041



KLP20031

**Figure 2. System Top Cover Removal**

1. Using a phillips screw driver, rotate the latch lock ¼ turn to the “Unlock” position (see Letter A).
2. Lift the latch to its full open position. The top cover will slide back (see Letter B).
3. Lift the back edge of the top cover, then slide the top cover back and away from the chassis (see Letter C).

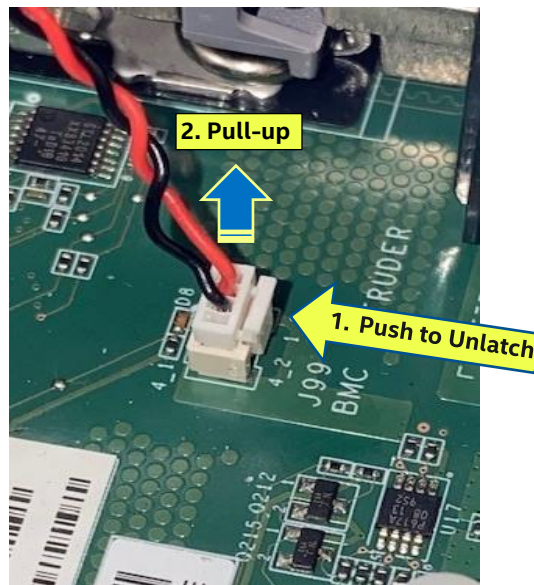
### 2.1.2 Air Duct Removal

---

**Note:** Instructions will be identical regardless of air duct type installed (Standard or Low Profile)

---

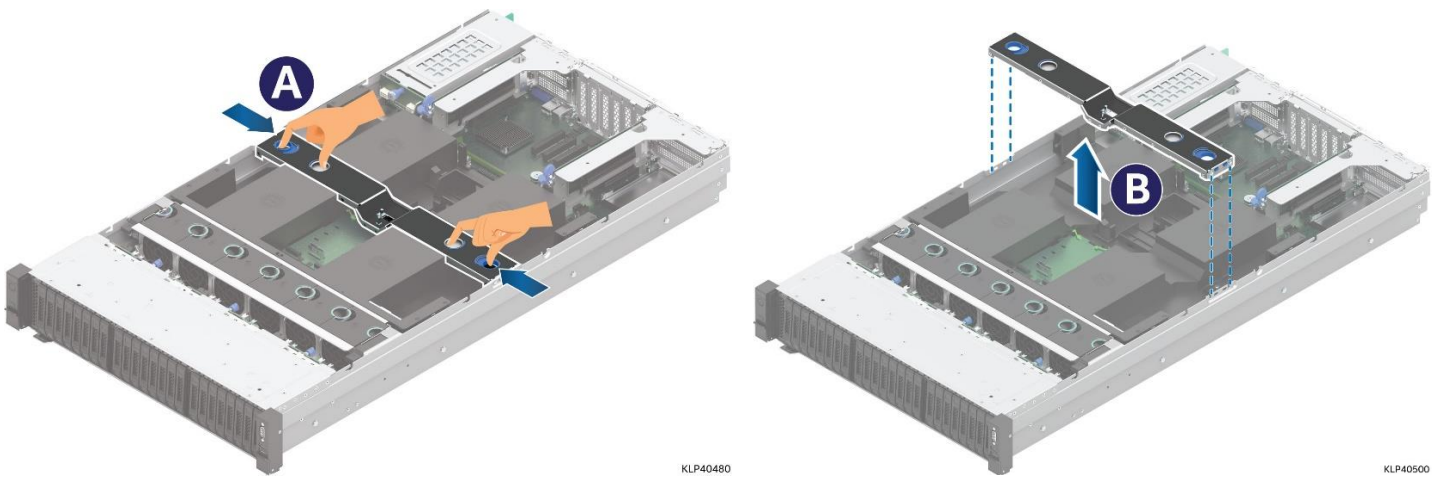
The air duct is held in place using a lock bar that must be removed prior to removing the air duct. Integrated within the lock bar assembly is a chassis intrusion switch that is cabled to the server board. This cable must be carefully disconnected from the server board before removing the lock bar.



**Figure 3. Chassis Intrusion Switch Cable Connection on Server Board**

1. Located below the back edge of the air duct, unlatch and disconnect the white two-wire chassis intrusion switch cable from the server board (see Figure 3).
  - **DO NOT pull on the wires to disconnect the cable.** Doing so may detach the wires from the connector.

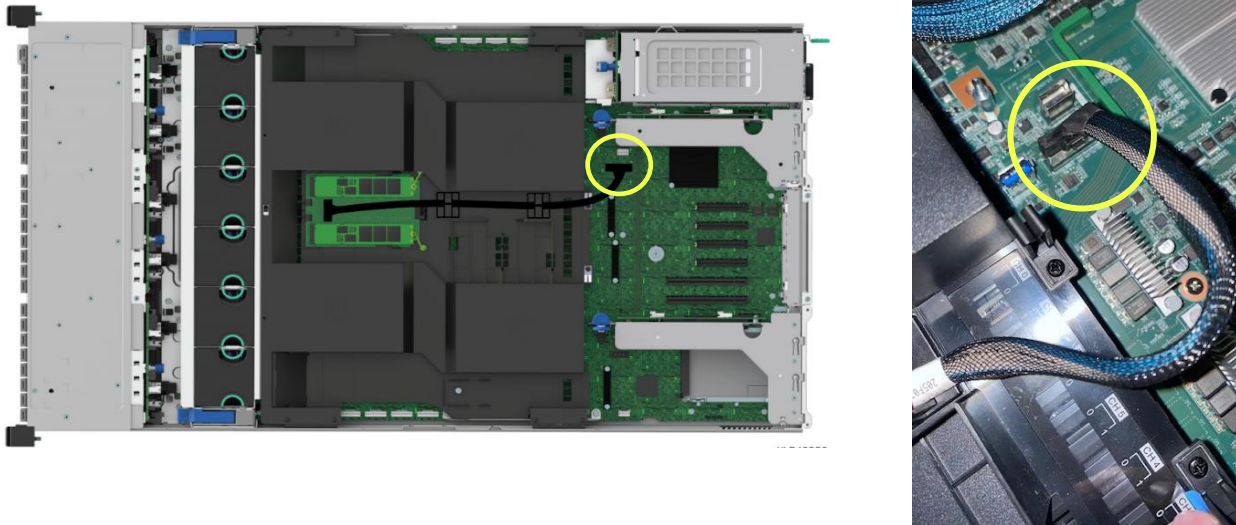




**Figure 4. Air Duct Lock Bar Removal**

2. Using both hands, squeeze and hold the lock bar latches (see Letter A).
3. Lift the lock bar up and away from the chassis (see Letter B).

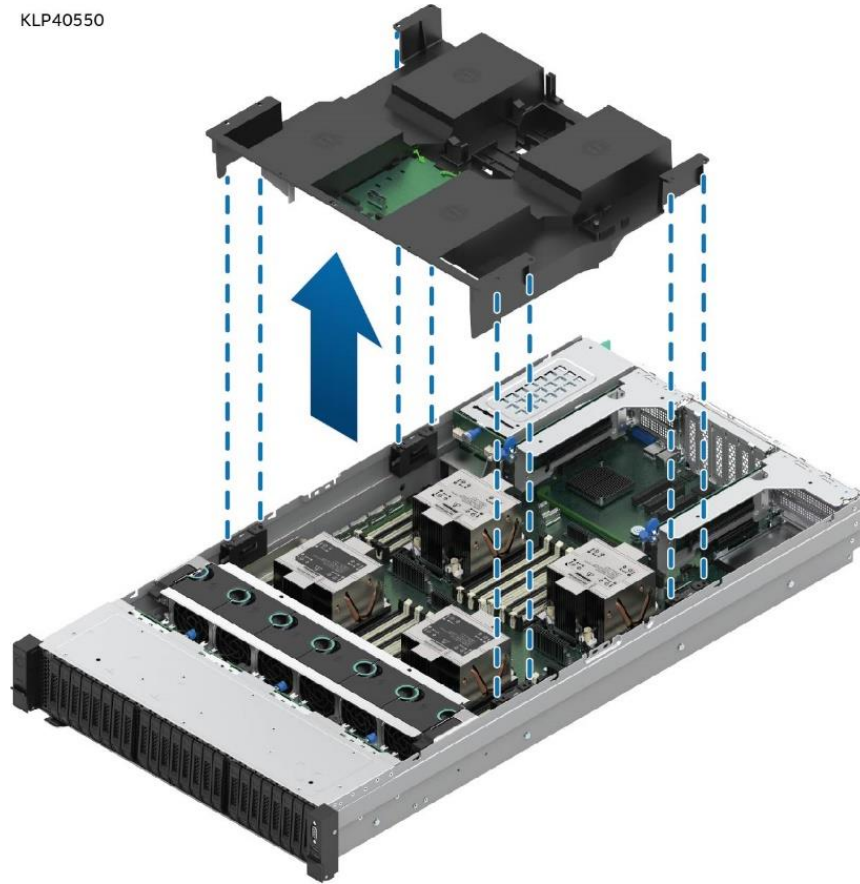
For systems that include an M.2 SSD Interface Board on top of the air duct, follow Step 4. Otherwise, proceed to Step 5.



**Figure 5. M.2 SSD Interface Cable Connection on Server Board**

4. Located below the back edge of the air duct, unlatch and disconnect the M.2 SSD interface cable from the server board (see [Figure 5](#)).

KLP40550



**Figure 6. Air Duct Removal**

5. Carefully lift the air duct up and away from the chassis (see [Figure 6](#)).

## 2.2 System Air Duct and Top Cover – Installation

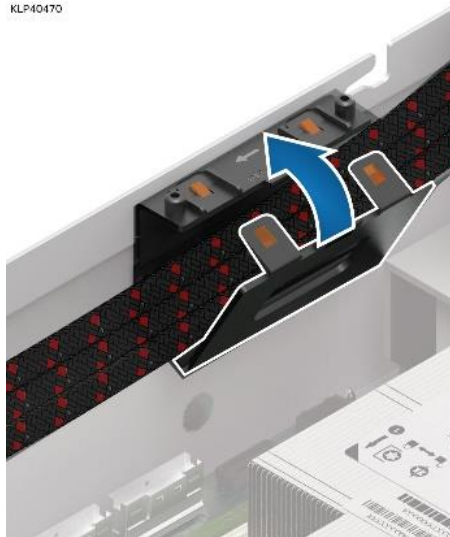
### 2.2.1 Air Duct Installation

Ensure that no cables interfere with placement of the air duct. Use the cable management brackets on each chassis sidewall to route cables as necessary (see [Figure 7](#)).

KLP40470

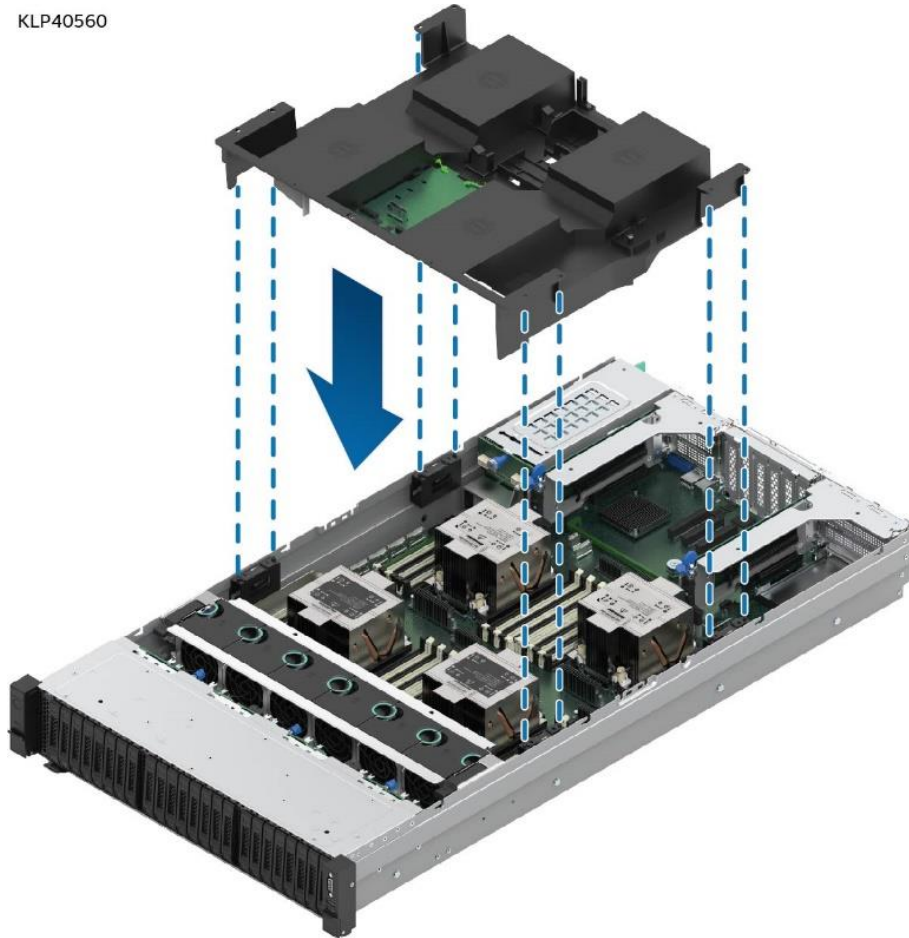


KLP40470



**Figure 7. Cable Management Brackets**

KLP40560



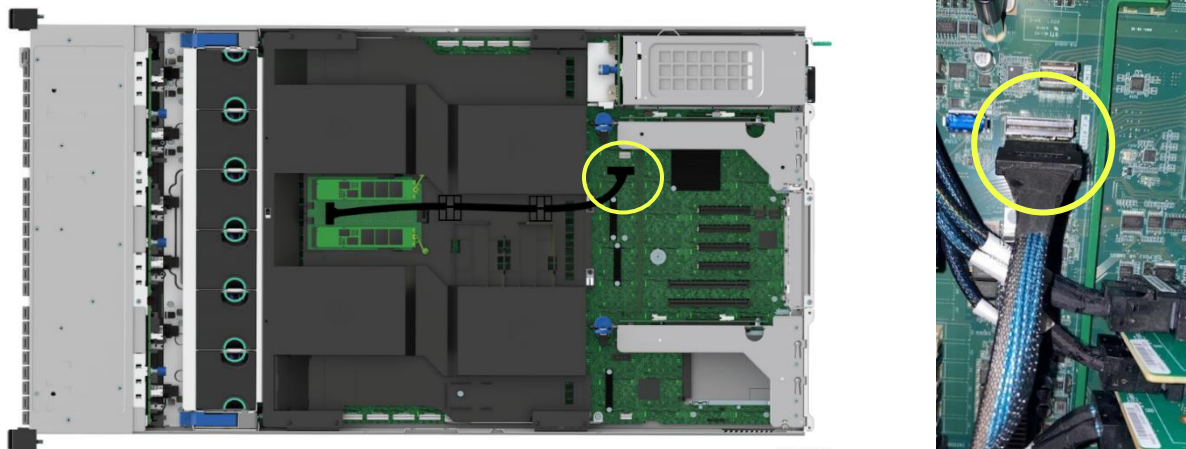
**Figure 8. Air Duct Placement**

1. Position the air duct over all alignment features.
  - Hold the air duct over the chassis and match alignment pins found on each cable management bracket to matching alignment holes on the air duct.
  - On the underside of the front edge of the air duct, there are two alignment pins that fit into matching holes on the system fan bracket.
2. Lower the air duct into the chassis such that it sits flat over each alignment feature (see [Figure 8](#)).

---

**Note:** The air duct lock bar and system top cover will not install unless the air duct sits flat over each alignment feature.

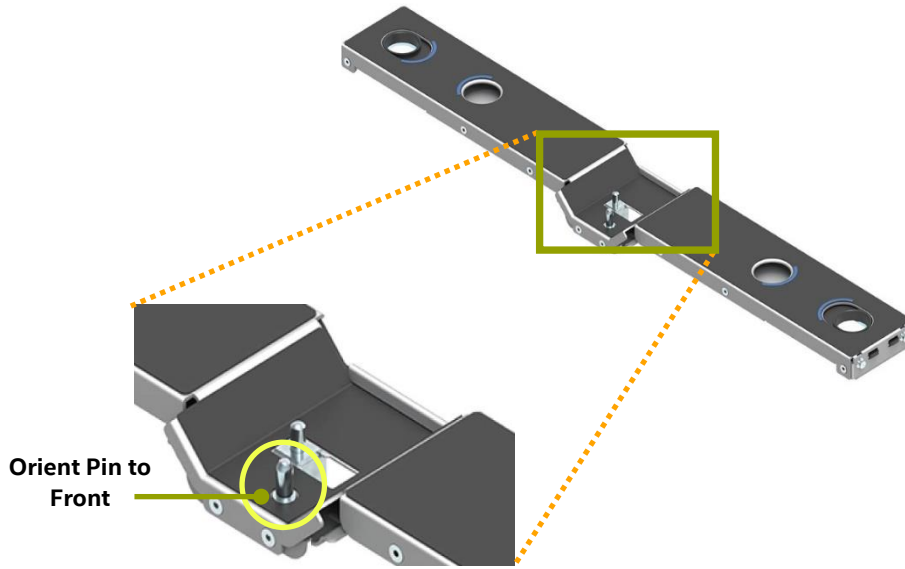
---



**Figure 9. M.2 SSD Interface Cable Installation to Server Board**

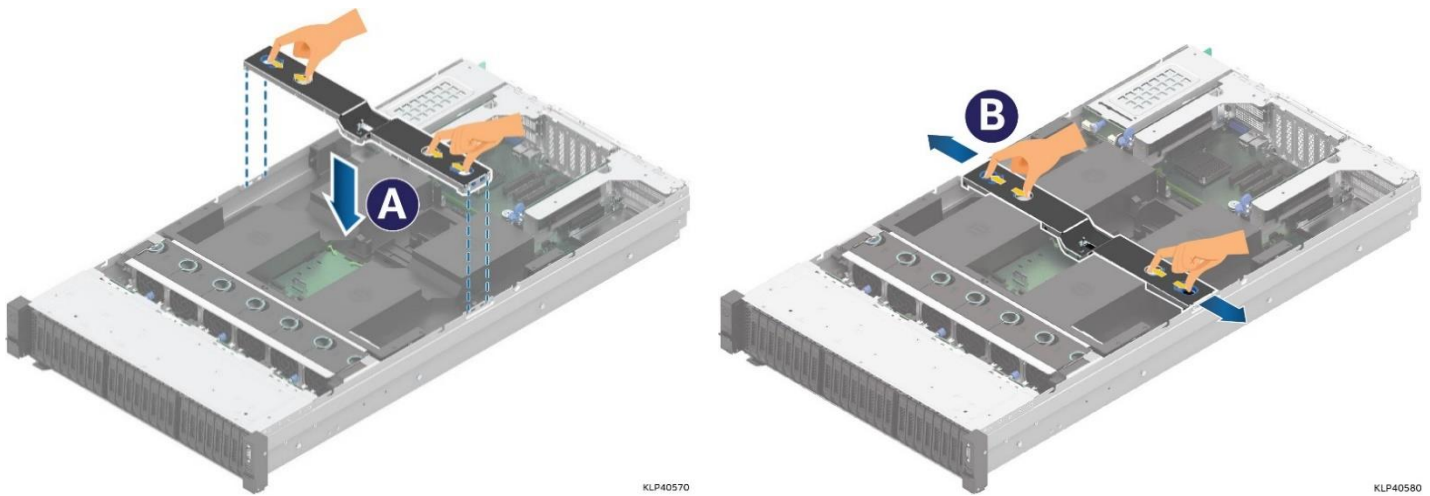


- (If present) Connect the M.2 SSD interface board cable to the slim-line connector on the server board below the back edge of the air duct (see [Figure 9](#)).
- Locate the air duct lock bar.



**Figure 10. Air Duct Lock Bar Orientation**

- Orient the lock bar so that the pin identified in [Figure 10](#), is closest to the front of the chassis.



**Figure 11. Air Duct Lock Bar Installation**

- Using both hands, squeeze together and hold the lock bar latches (see Letter A).
- Lower the lock bar into place ensuring the alignment pins found on both ends of the lock bar slide into the matching slots on the chassis (see Letter A).
- Release the lock bar latches and ensure the lock bar is securely locked in place (see Letter B).





**Figure 12. Chassis Intrusion Switch Cable to Server Board**

9. Orient the latch of chassis intrusion cable connector to the cut-out keyed side of the 4-pin connector on the server board (see above figure).
10. Carefully attach the cable to the server board connector until fully seated and locked in place.

### 2.2.2 System Top Cover Installation

---

**Note:** The system top cover will not install unless the air duct and air duct lock bar are properly installed and locked in place.

---

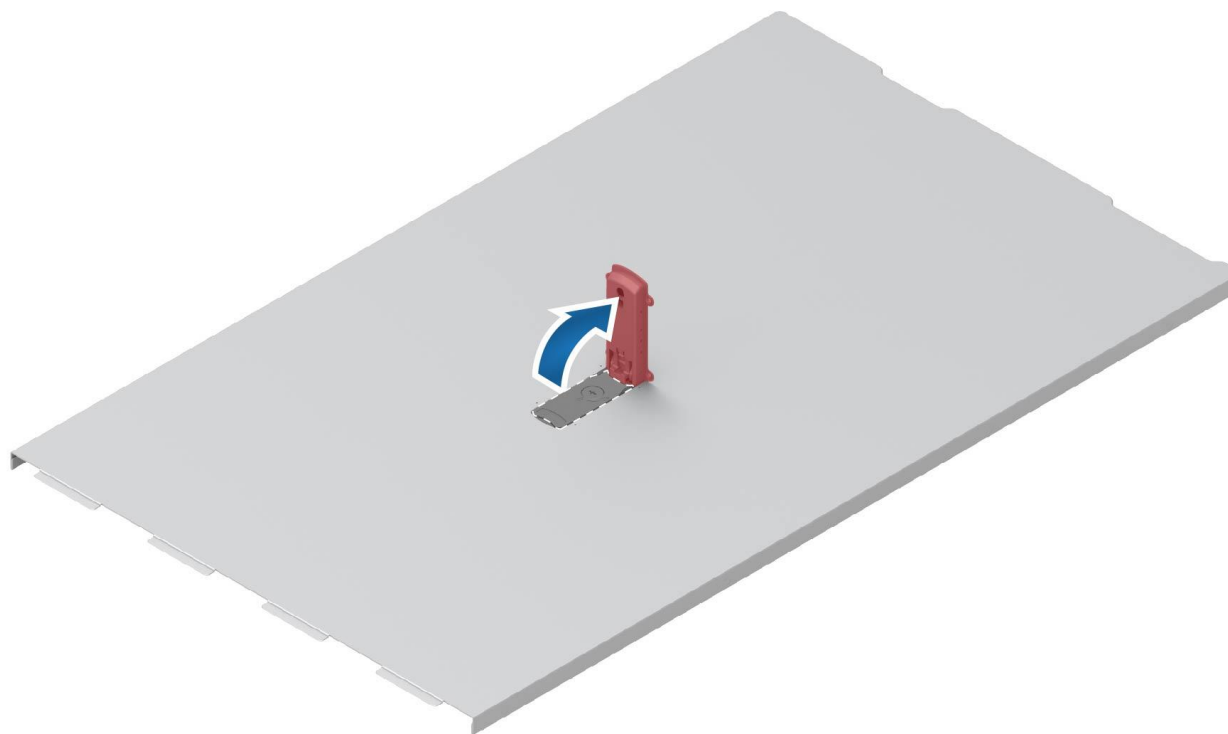
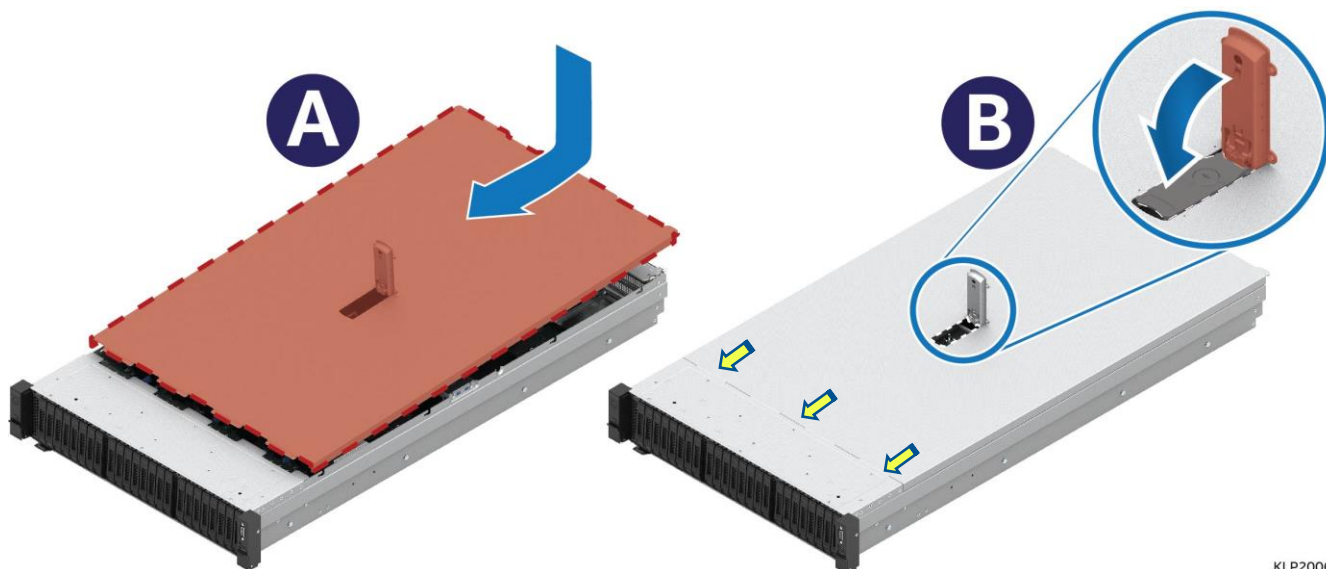


Image number: KLP20190

**Figure 13. Open Top Cover Latch**

1. Lift the top cover latch to its fully open position.



KLP20061

**Figure 14. Top Cover Placement**

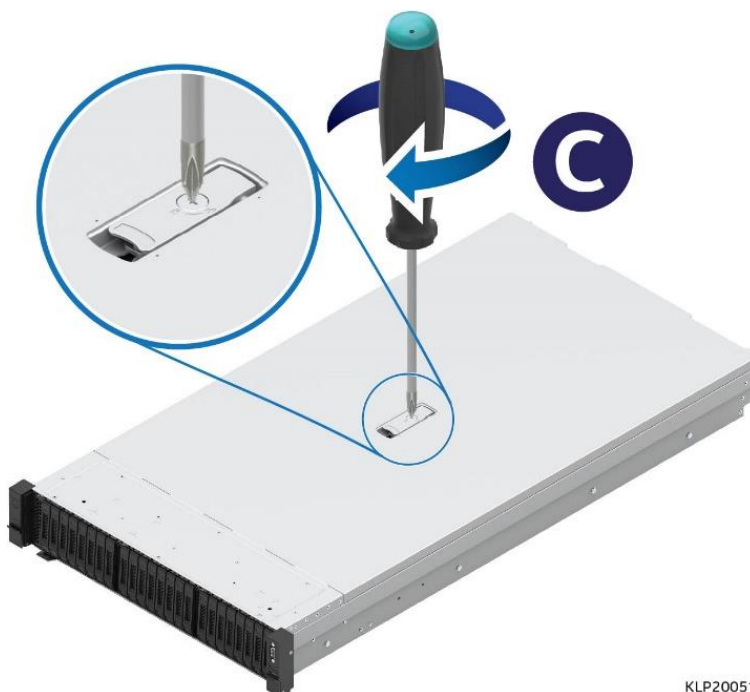
- Align and lower the top cover onto the chassis and slide forward until it stops (see Letter A).

---

**Note:** the top cover will not be fully engaged with the chassis in this step.

---

- Close the top cover latch until fully locked. The top cover will slide forward to its final seated position (see Letter B).



KLP20051

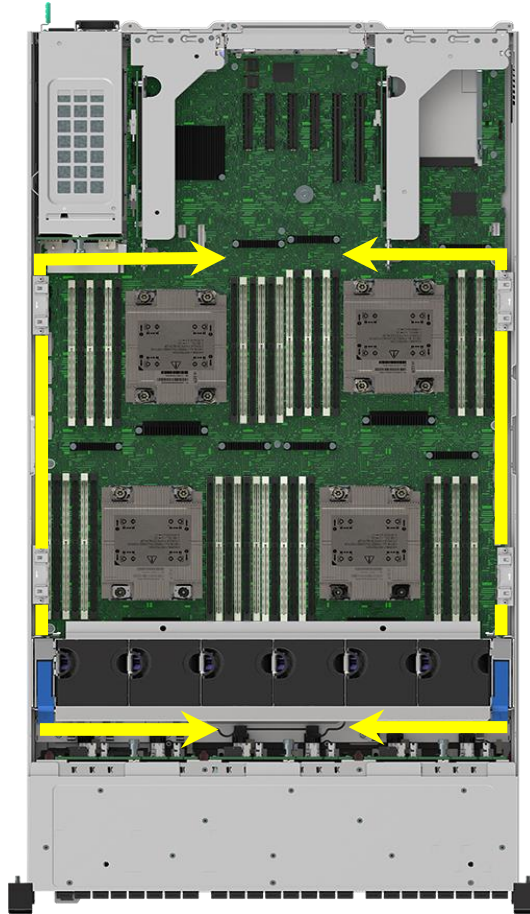
**Figure 15. Top Cover Latch Lock**

- To lock the top cover latch, insert a Philips head screwdriver into the latch lock, and rotate  $\frac{1}{4}$  turn to its locked position (see Letter C).

## 2.3 Cable Routing

Proper cable routing and management within the system is necessary to correctly install the system air duct. In addition, managing how cables are routed within the system is critically important for proper airflow and maintaining system thermals. Internal cables routed improperly can block airflow to critical components and areas within the chassis causing them to heat up beyond their thermal limits that can impact system performance and longevity.

When routing cables to or from the area behind the front drive bay, they must be routed using cable channels along the chassis sidewalls as shown in Yellow arrows below. No cables should be routed through the center of the system.



**Figure 16. Cable Routing Channels**

Several features designed within the chassis help to manage cables and create an aesthetically clean looking system.

### 2.3.1 Cable Management Brackets

Mounted to each chassis sidewall are two cable management brackets as shown in the following figure.

Open bracket to install cables



Close bracket to secure cables



Cables routed and secured



Figure 17. Internal Cable Management

### 2.3.2 System Fan Housing – Removal / Installation

To route cables to/from the area behind the front drive bay, the system fan housing must be removed from the chassis. The fan housing is modular allowing for tool-less removal and installation.

#### 2.3.2.1 Fan Housing Removal

1. (If installed) Remove the system air duct from the chassis (see [Section 2.1.2](#)).

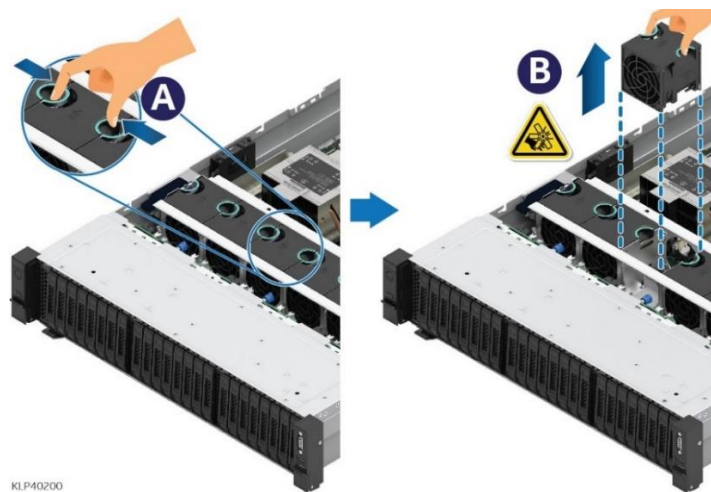
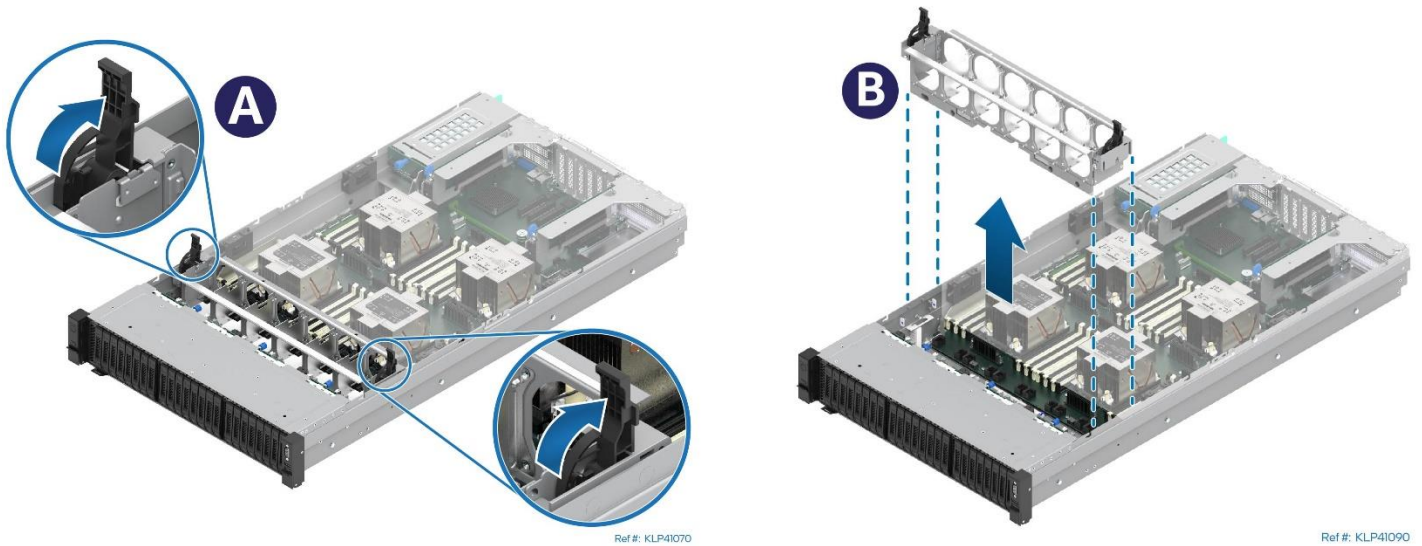


Figure 18. System Fan Removal

2. Remove all 6 system fans from the fan housing.
  - Using the finger grips atop of each system fan, squeeze and pull each fan up from the housing.

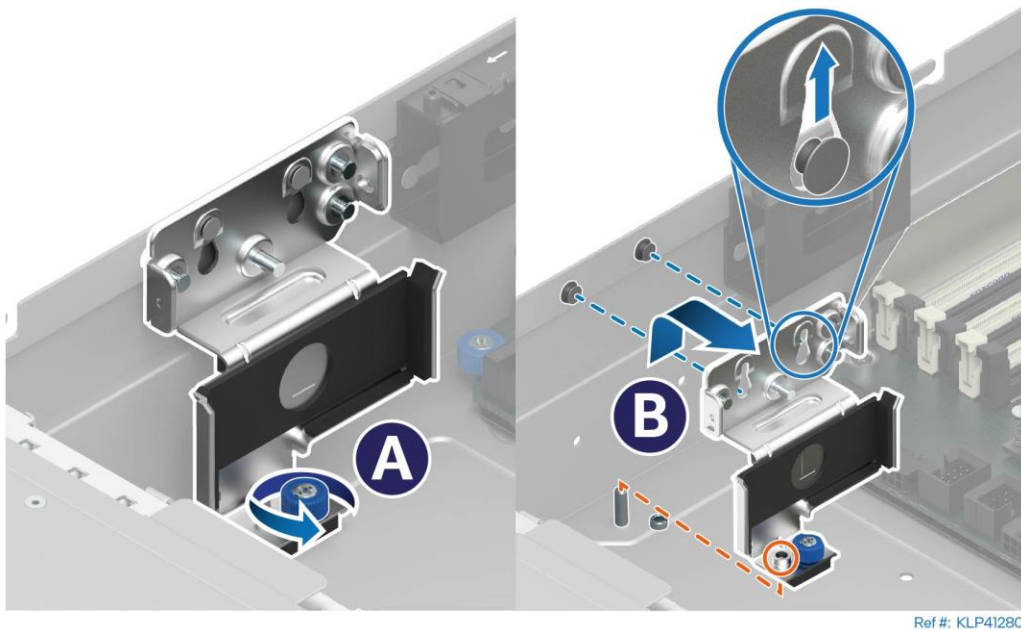




**Figure 19. System Fan Housing Removal**

3. Lift the latches on both ends of the fan housing to their full upright position (see Letter A).
4. Grasp the fan housing on both ends and pull it straight up from the chassis (see Letter B).

To route cables to/from the area behind the front drive bay, the fan housing mounting bracket attached to the chassis sidewall must be removed, allowing cables to be routed through the channel below it.



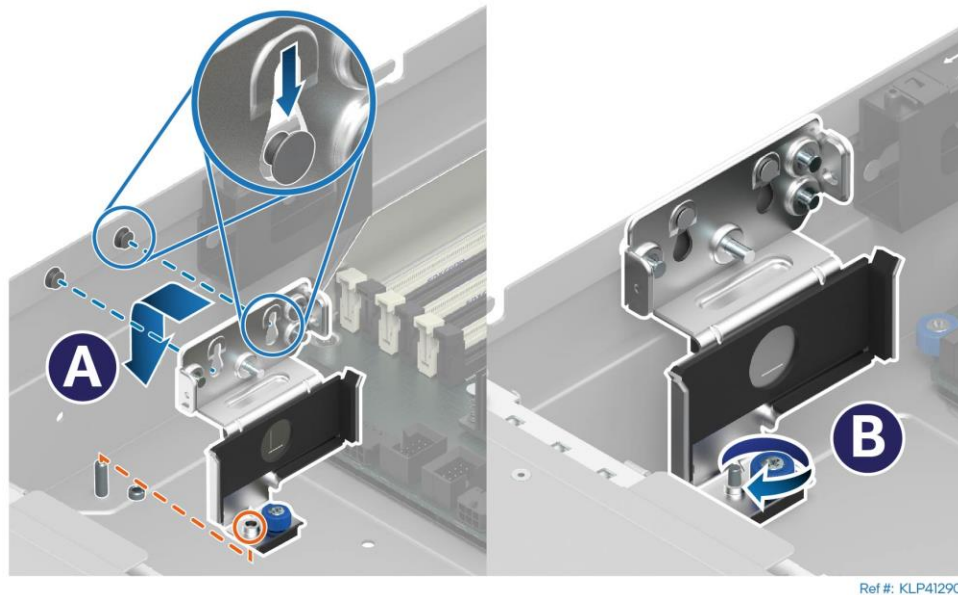
**Figure 20. Fan Housing Mounting Bracket Removal**

5. Loosen the blue thumbscrew of the chosen fan housing mounting bracket (see Letter A).
6. Lift and pull the mounting bracket away from the chassis sidewall (see Letter B).
7. (If necessary) Repeat steps 5 and 6 to remove the fan housing mounting bracket from the opposite chassis sidewall.
8. Attach and route cables as necessary.

### 2.3.2.2 Fan Housing Installation

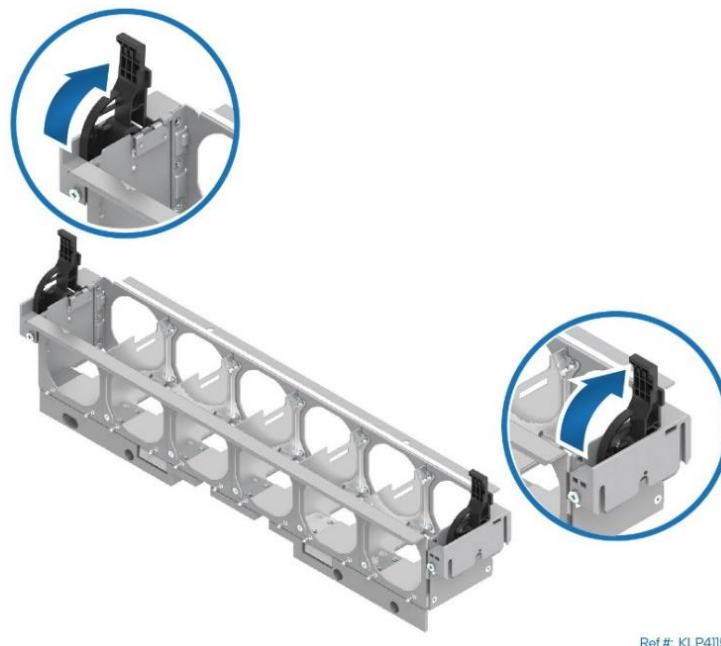
1. (If removed) Reinstall one or both fan housing mounting bracket(s) to the chassis sidewall.

**Note:** Each mounting bracket is stamped (L) or (R) to identify which side of the chassis the bracket mounts to.



**Figure 21. Fan Housing Mounting Bracket Installation**

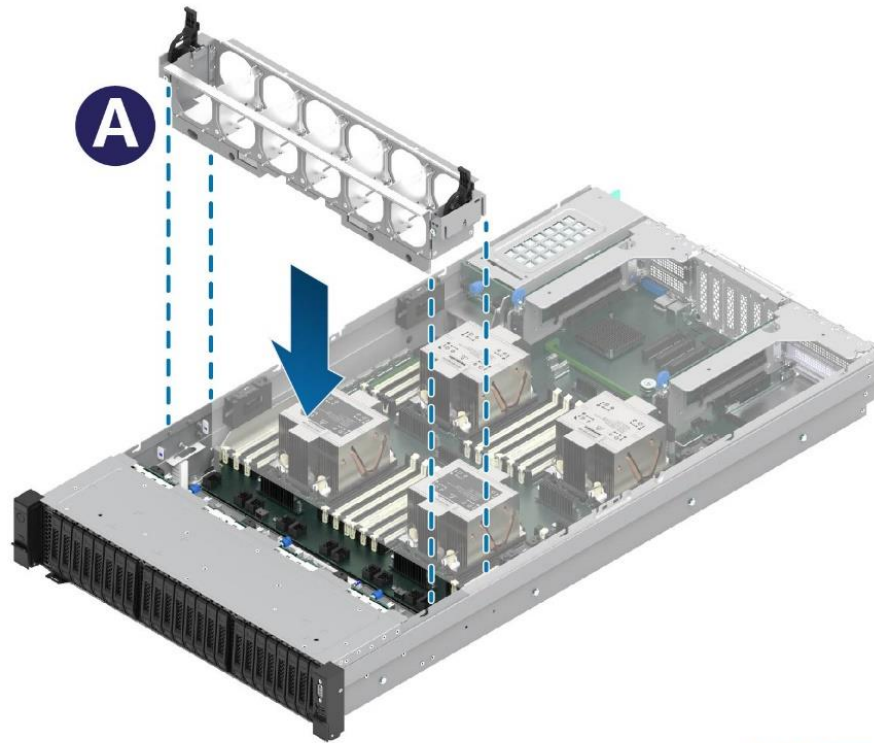
- Match the bracket identifier (L) or (R) to the proper side of the chassis.
- Align the two key holes of the mounting bracket to the mounting studs on the chassis sidewall.
- Place the mounting bracket over the mounting studs and push the bracket down over the alignment pin on the chassis base until seated (see Letter A).
- Tighten the blue thumbscrew to secure the mounting bracket (see Letter B).



Ref #: KLP41150

**Figure 22. System Fan Housing – Open Latches to Install**

2. Lift the latches on both ends of the empty fan housing.



Ref #: KLP4100

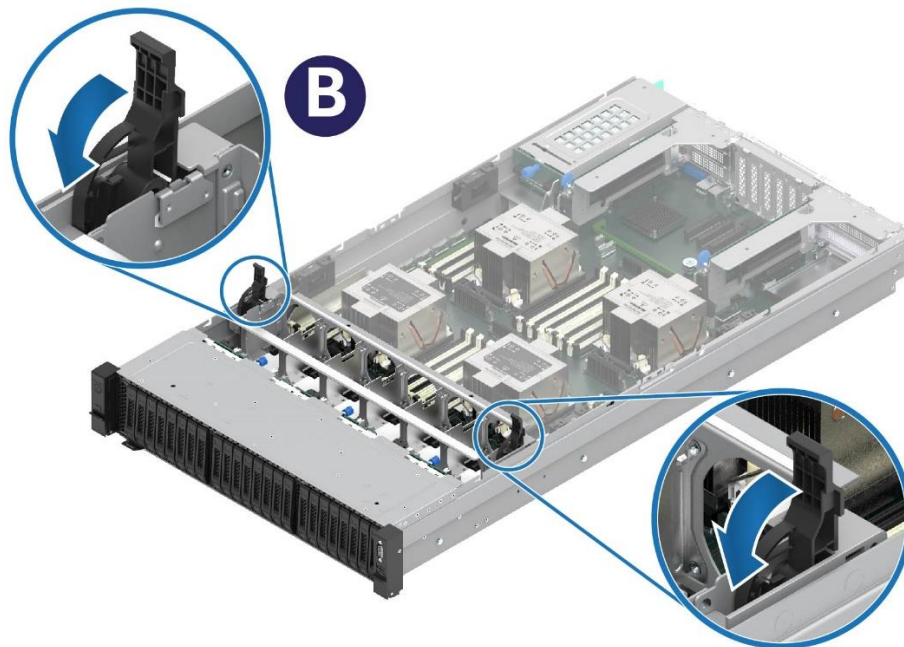
**Figure 23. System Fan Housing Placement**

3. Align the slots on both ends of the fan housing to the alignment pins of the mounting brackets on the chassis sidewalls (see Letter A).
4. Lower the fan housing into the mounting bracket until it stops.

---

**Note:** Do NOT push down further on the fan housing.

---



Ref #: KLP41070

**Figure 24. System Fan Housing – Close Latches**

5. Close both fan housing latches at the same time. The housing will position and secure itself to the chassis (see Letter B).

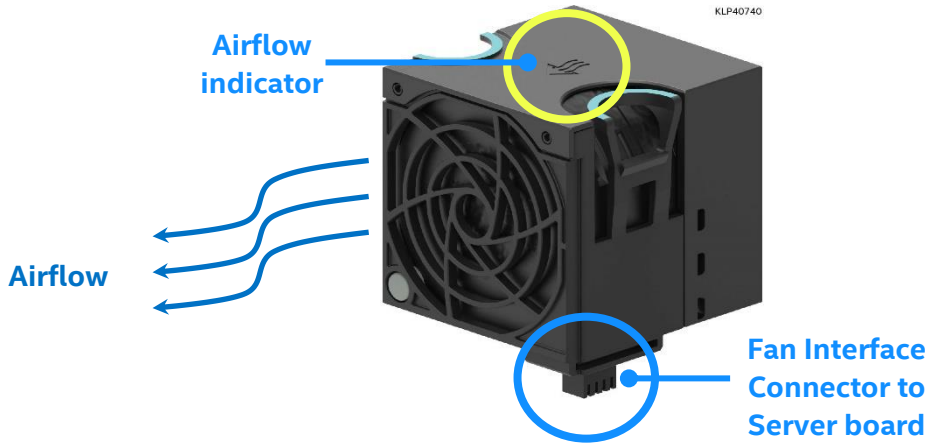


Figure 25. System Fan Placement Orientation Features

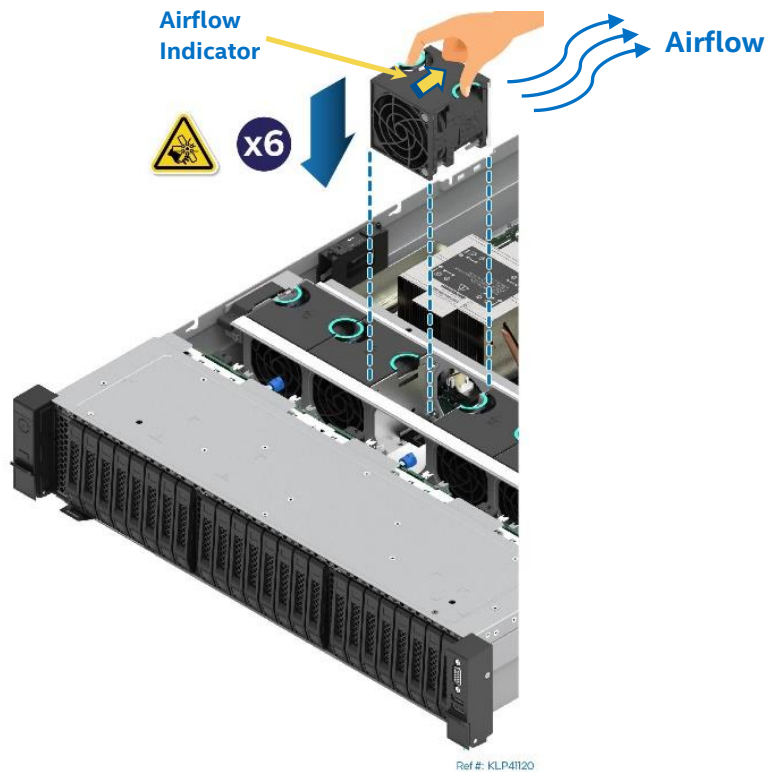


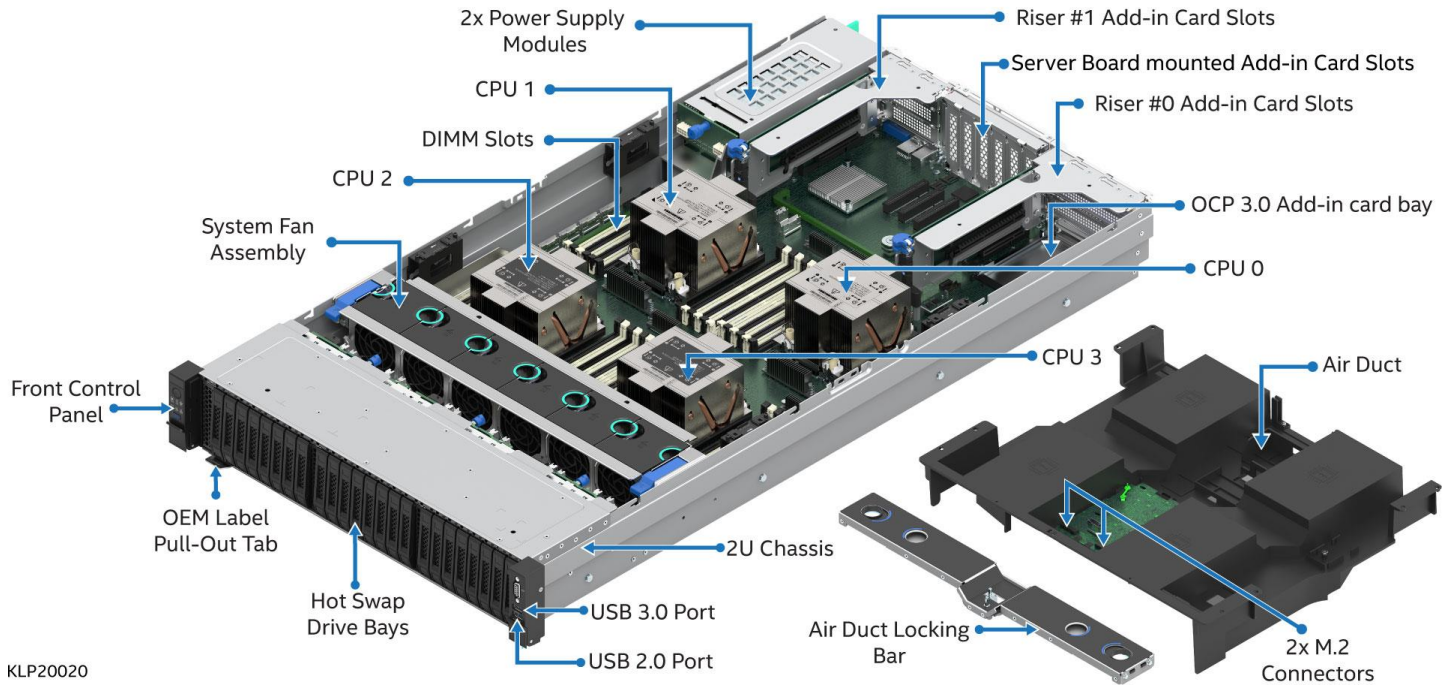
Figure 26. System Fan Installation

6. Reinstall all system fans into the fan housing.
  - Orient the system fan so that the airflow symbol atop the fan is pointing to the back of the system.
  - Gently squeeze together the finger grips atop of the system fan and insert it into the fan housing.
  - Push down on the fan until fully seated and release it. The fan should be locked in place.
  - Repeat steps for all six fans.



### 3. System Options and Accessories

This chapter provides instructions for the integration of system options and other available Intel accessories. See [Chapter 5](#), “FRU Replacement” for complete replacement instructions for components identified as field replaceable.



KLP20020

**Figure 27. System Features Identification**

#### Before You Begin

Before integration of any system components, review all the safety and ESD precautions found in the Safety Warnings section at the beginning of this document.

#### System Reference

In the following procedures, all references to left, right, front, top, and bottom assume the reader is facing the front of the server chassis.

#### Instruction Format

Each procedure described in this chapter follows an illustration first format. This format gives the reader the option to follow a quicker path to completing the objective by first seeing an illustration of the intended procedural step or steps. If necessary, the reader can follow the step-by-step instructions that follow each illustration.

### 3.1 Rail Kit Installation

The Intel® Server System M70KLP includes a rail kit for system installation into a 4-post rack or cabinet. The following installation guidelines should be observed.

- For proper system ventilation, leave a minimum of 15 cm clearance in the front and rear of the system.
- Servers are high-power electrical appliances. They should be installed into dedicated cabinets with vents or professional water-cooled cabinets to prevent system failures caused by overheating.
- If installing more than one server or component into a given rack or cabinet, begin installing them from the bottom and load the heaviest items first.
- Note the cabinet's load-bearing capacity, power source capacity, and heat dissipation capacity. Be sure not to install devices that go beyond the cabinet's capacity thresholds.
- For the convenience of using the front and rear ports of the system and to allow for cabling, leave a minimum clearance of 70 mm between the front of the server and the inside of the cabinet's front door. Leave 150 mm between the back of the system and the inner side of the cabinet's back door.
- Due to the weight of a system, Intel recommends carrying the system with two or more people supporting the system from the sides, using a mechanical lift, or a cart when moving the system from one location to another.
- If your system has rack handles installed, do not lift, or carry the system solely by the rack handles. These handles are intended for the sole purpose of pulling a system from or pushing it into a rack.
- When lifting or moving a system, it is best to grasp and lift it by all four corners using two or more people. Do not grasp and lift the system by two opposing diagonal corners. Doing so will flex the chassis that may damage the internal system components.
- With no other option available but to lift the system using only two points of contact, grasp and lift the system at the mid-point of each side of the system.

#### Installing the rails:

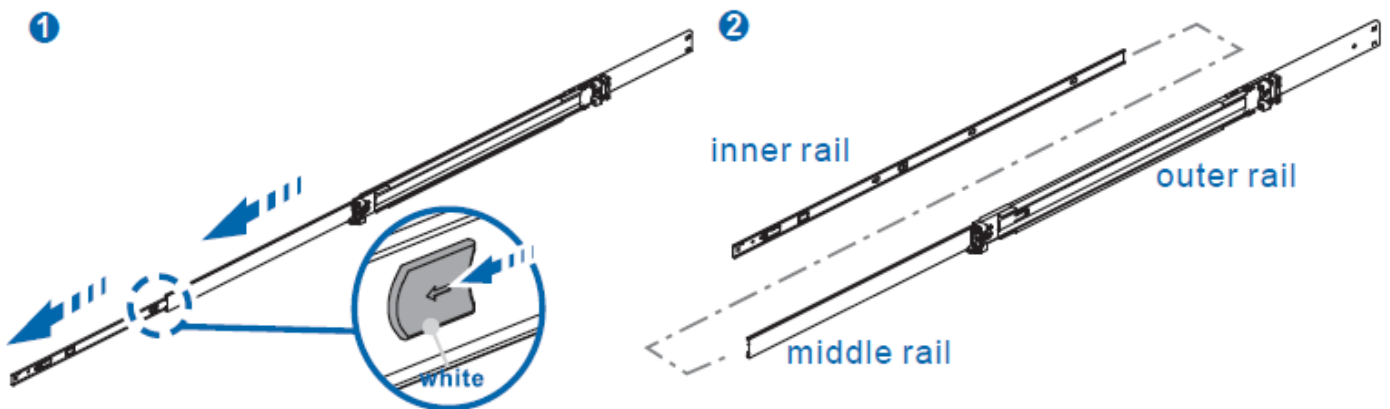
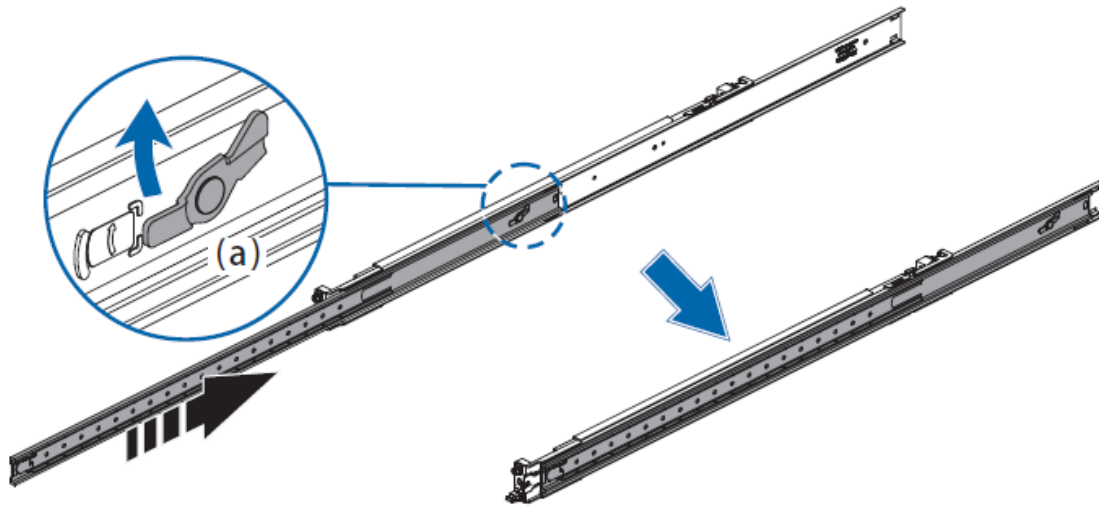


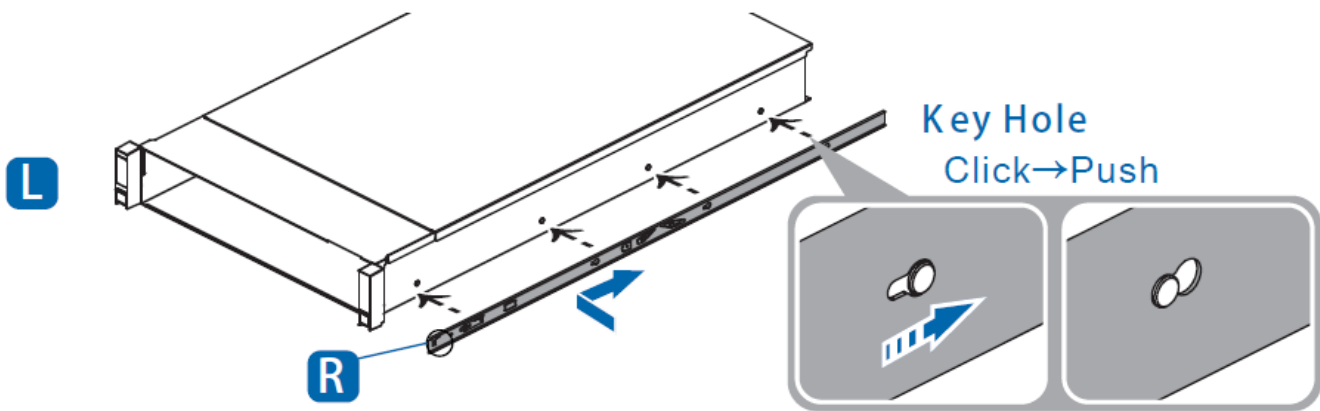
Figure 28. Rail Kit - Inner Rail Removal

1. Remove the Inner Rail from the Right and Left rail assemblies.
  - Pull the white tab and pull out the inner rail



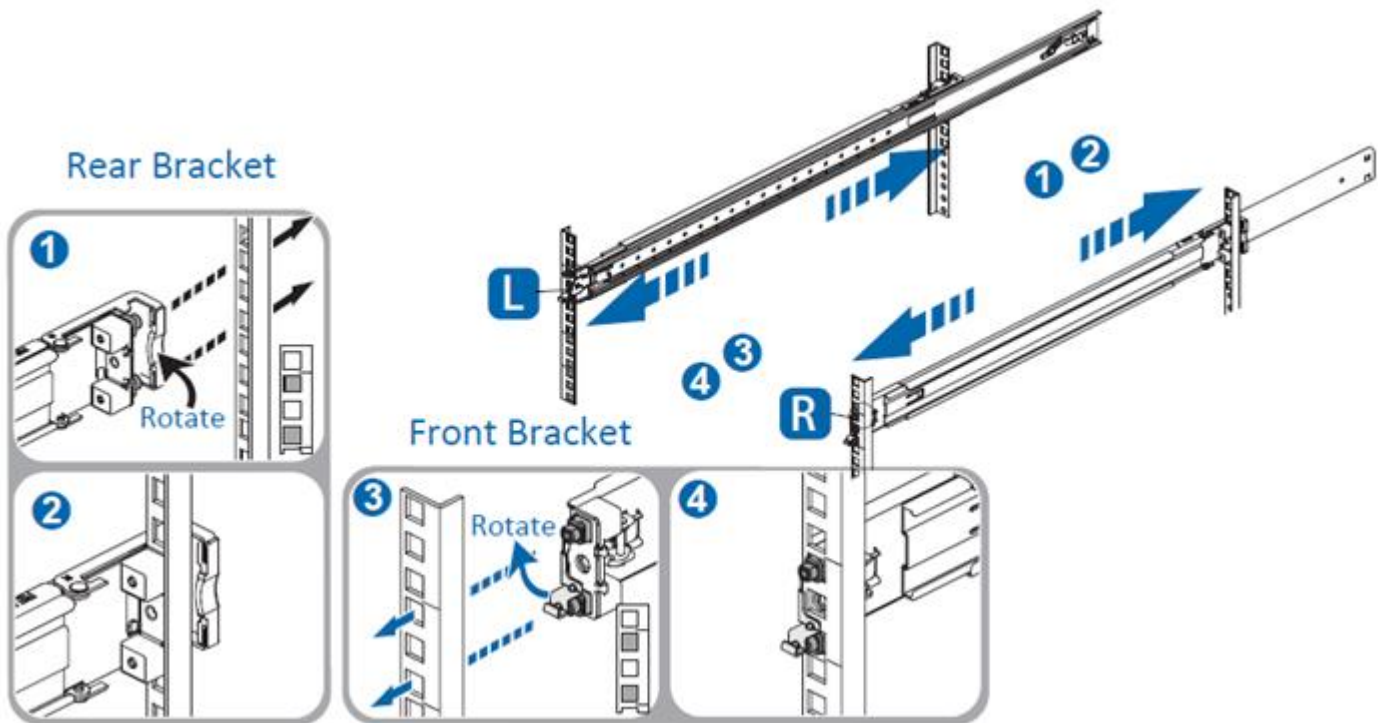
**Figure 29. Rail Kit – Re-position Middle Rail**

2. Rotate the tab (a) and slide the middle rail back into the outer rail.



**Figure 30. Rail Kit - Inner Rail Attachment to Chassis**

3. Install the (L)eft and (R)ight inner rail segments to the appropriate side of the server.
  - Align the key holes of the inner rail segment to the matching mounting studs on the side of the server.
  - Place the inner rail segment over the mounting studs and push the rail towards the back of the server.



**Figure 31. Rail Kit - Rail Installation to Mounting Posts**

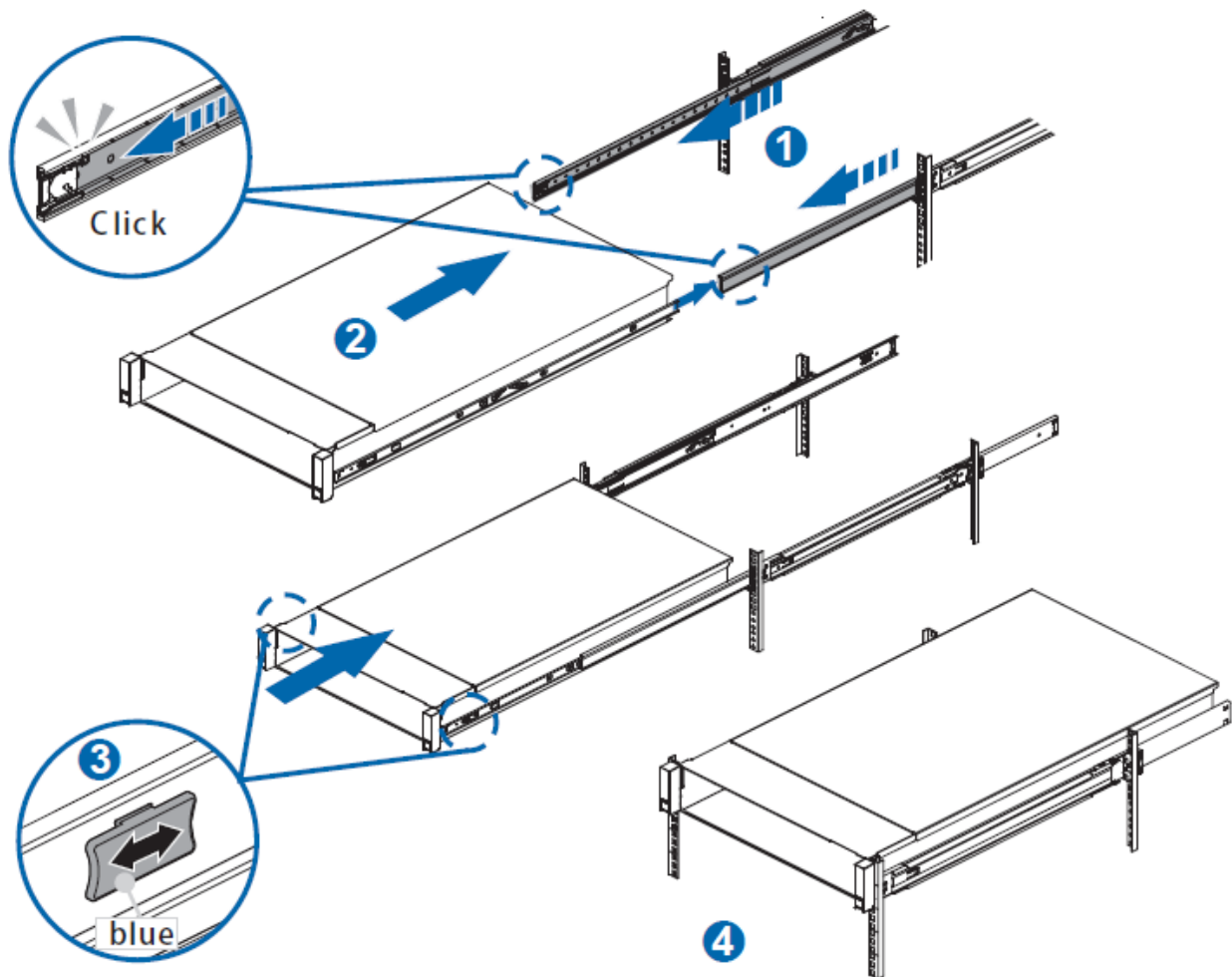
4. Install the rails one at a time to the back and front posts of the rack or cabinet.
  - Position the Rear Bracket along the outside of the rear post and push pins into the post from the back (see “Rear Bracket” steps 1 and 2).
  - Rotate pin to lock rail to post.
  - Extend the rail forward to install the front mounting bracket to the front post.
  - Insert Front Bracket pins through the backside of the front post and lock them in place (see “Front Bracket” steps 3 and 4).
  - Repeat for the second rail.

---

**Caution:** To prevent systems from falling within the rack or cabinet causing damage to the system and/or rail from occurring, ensure that both rails are securely attached to the posts and that each rail is mounted identically to the same mounting hole locations on each post. Installed rails for a given system must be parallel and at the same height within the rack.

---

**Caution:** The server system is very heavy. It is highly recommended that two or more people and/or the aid of a mechanical lift be used to install the server into the rack or cabinet.



**Figure 32. Rail Kit - Server Installation into Rails**

5. Install the server into the rails.
  - Fully extend the middle rail segment out from each installed rail (see number 1).
  - Position the system so that each inner rail segment on the side of the system is aligned to a rail extending from the rack.
  - Insert the system into each middle rail segment and push it into the rack until it stops (see number 2).
  - Slide (forward or back) the Blue release tab on each inner rail segment and push the system the remaining length until fully installed (see number 3).
  - Using the lock screws on each system handle, lock the server to the front posts.



## 3.2 Add-in Card Installation and Removal

PCIe\* add-in cards can be installed to any available PCIe add-in cards slots found on the server board and/or to installed riser cards (if present). No tools are required to install or remove a PCIe add-in card.

### 3.2.1 PCIe\* Add-in Card Installation - Server Board Add-in slots

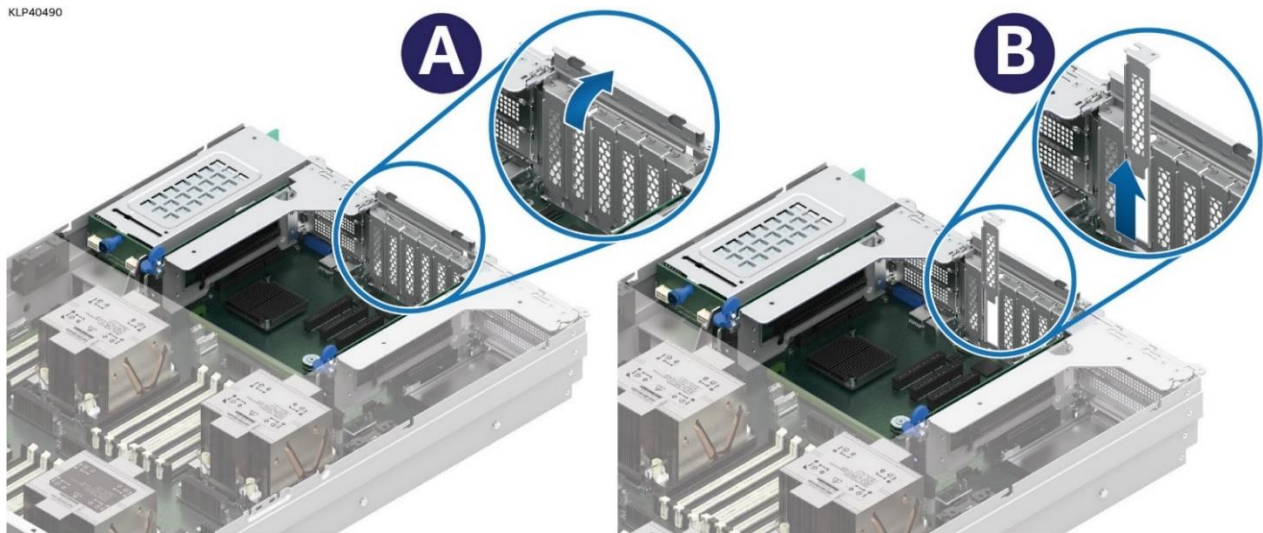
The server board can support vertically mounted Half-Height, Half-Length PCIe add-in cards.

#### Required Tools and Supplies

- Anti-static wrist strap and conductive workbench pad (recommended)

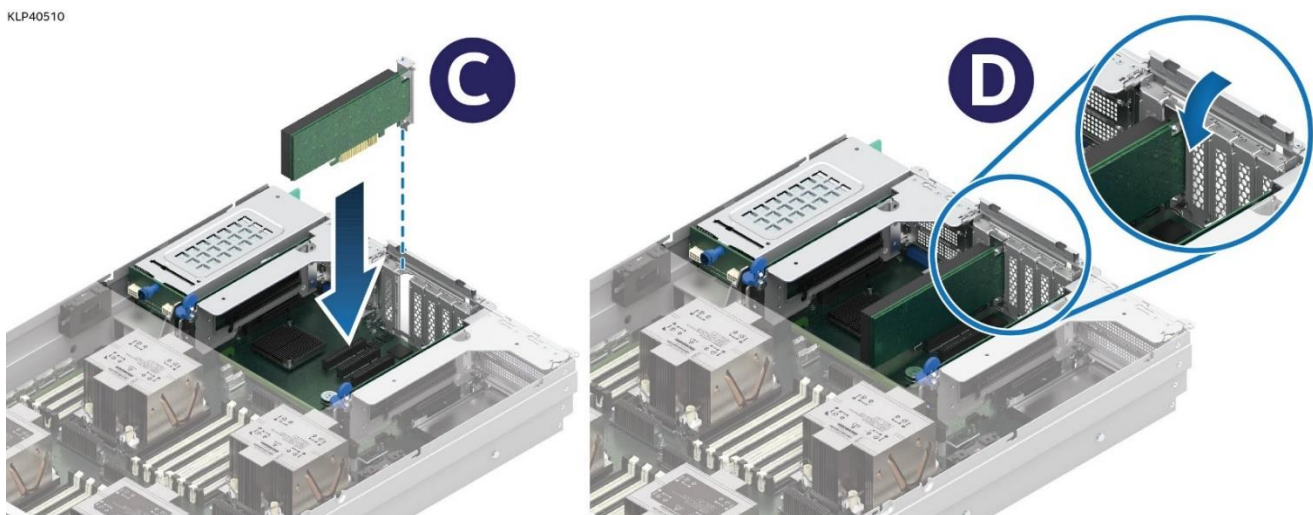
#### System Prerequisites

- The system must be powered off and AC Power cord(s) disconnected



**Figure 33. Add-in Card to Server Board - Filler Plate Removal**

1. Lift open the silver filler plate retention latch on the top edge of the back panel (see Letter A).
2. Remove the filler plate for the desired add-in slot (see Letter B).



**Figure 34. Add-in Card to Server Board - Card Installation**

3. Align the edge connector of the add-in card over the desired add-in slot (see Letter C).
4. Insert the add-in card into the slot using even downward pressure until the card is fully seated.
5. Close the filler plate retention latch until it snaps into place (see Letter D).

### 3.2.2 PCIe\* Add-in Card Removal - Server Board Add-in slots

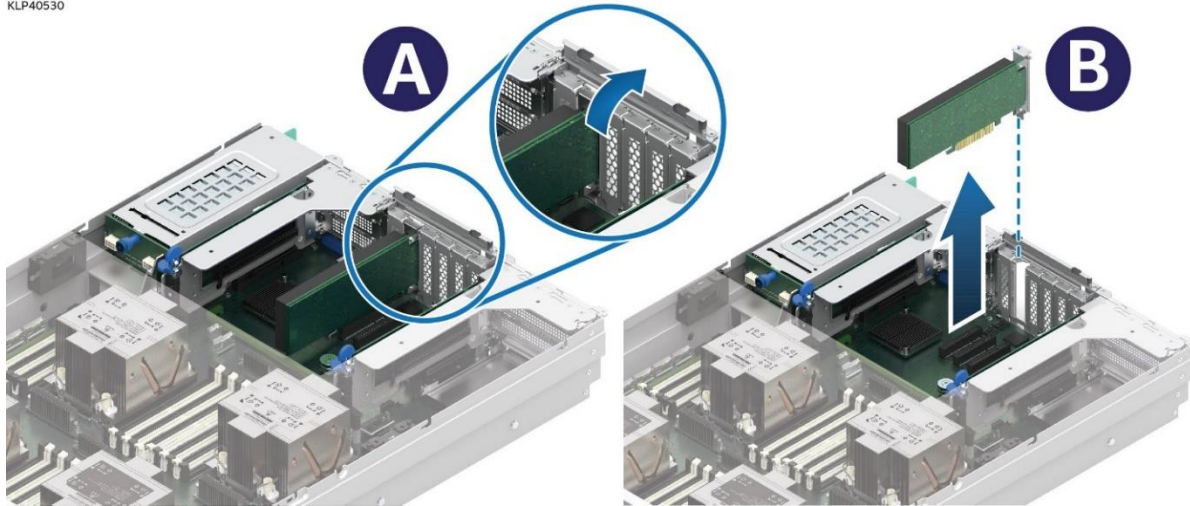
#### Required Tools and Supplies

- Anti-static wrist strap and conductive workbench pad (recommended)

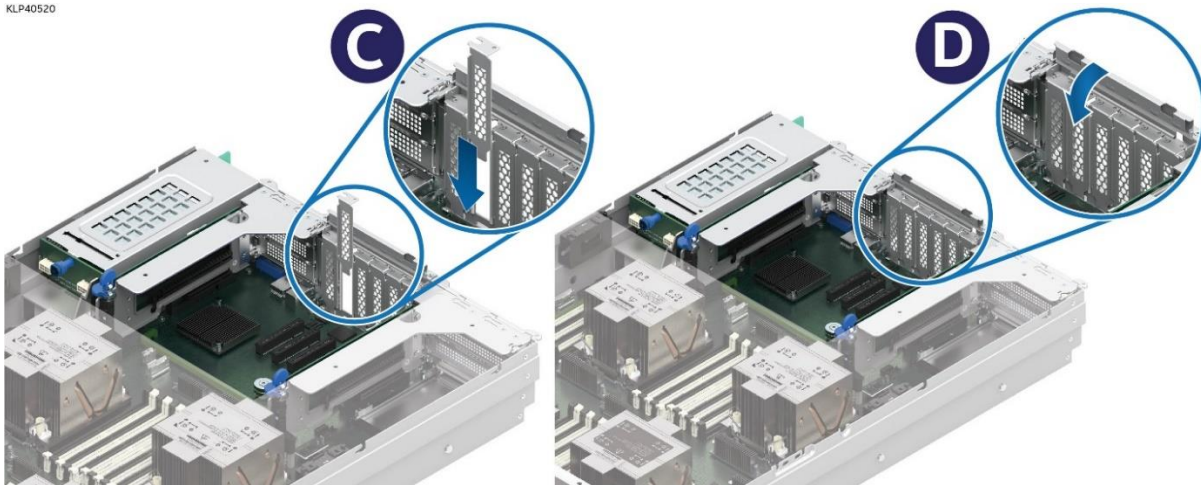
#### System Prerequisites

- The system must be powered off and AC Power cord(s) disconnected
- (If present) Disconnect any external cables attached to the card(s) being removed

KLP40530



KLP40520



**Figure 35. Add-in Card removal from Server Board**

1. Lift open the silver filler plate retention latch on the top edge of the back panel (see Letter A).
2. (If present) Carefully detach all internal cables attached to the card being removed
3. Carefully lift the add-in card from the server board (see Letter B).
4. Insert a filler plate to the open slot on the back panel (see Letter C).
5. Close the filler plate retention latch until it snaps into place (see Letter D).

---

**Note:** All add-in card slots on the back panel must be populated with an add-in card and back plate or a supplied filler plate. Operating a system with an open back panel slot is not supported and may alter system airflow and/or impact electromagnetic interference (EMI) emission levels generated from the server.

---



### 3.2.3 PCIe\* Add-in Card Installation – Riser Cards

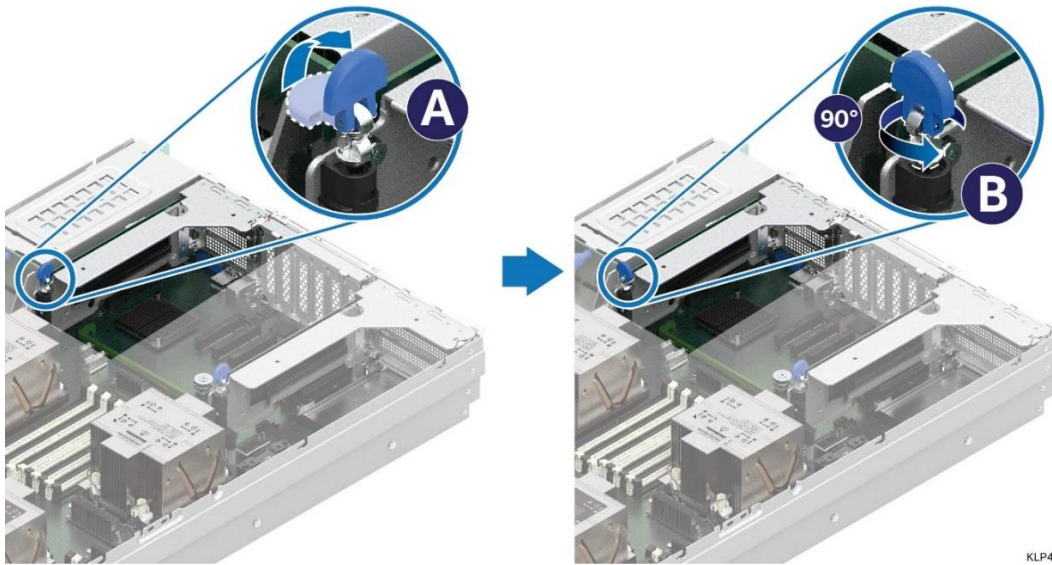
The following illustrations show the Riser 1 assembly. However, the instructions to add or remove an add-in card is the same regardless of riser card assembly location.

#### Required Tools and Supplies

- Anti-static wrist strap and conductive workbench pad (recommended)

#### System Prerequisites

- The system must be powered off and AC Power cord(s) disconnected



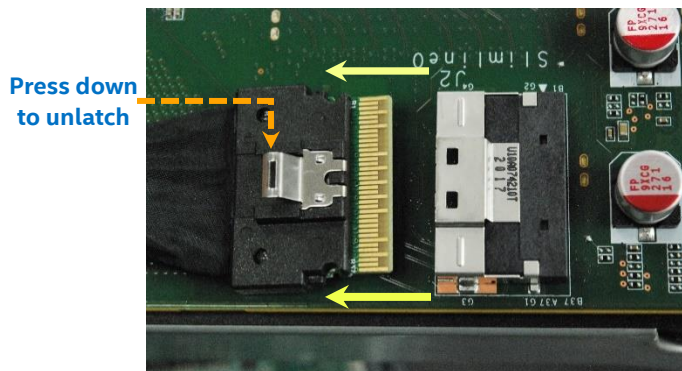
KLP40220

1. Fold up the blue tab on the end of the riser assembly (see Letter A).
2. Rotate the blue tab counterclockwise ¼ turn to release the riser assembly from the server board (see Letter B).

---

**Note:** To fully remove the riser assembly from the system, it may be necessary to first disconnect all auxiliary PCIe cables (if present) from the back side of the riser card.

---



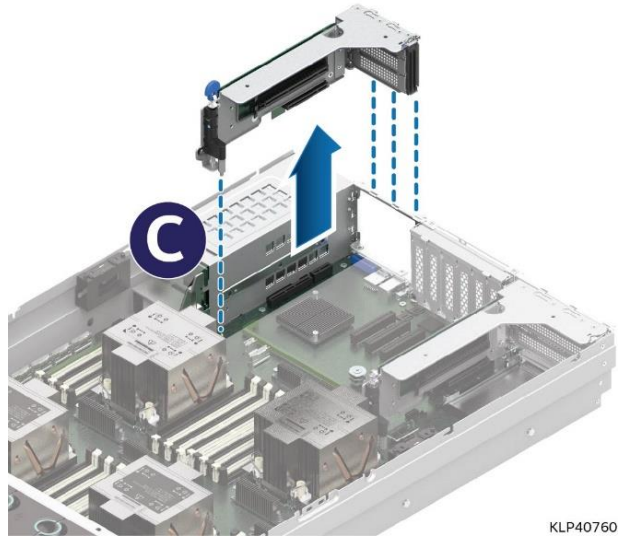
- Unlatch and pull the cable from the connector

---

**Note:** Remove the cable by grasping the plastic cable connector. Do not pull on the cable itself

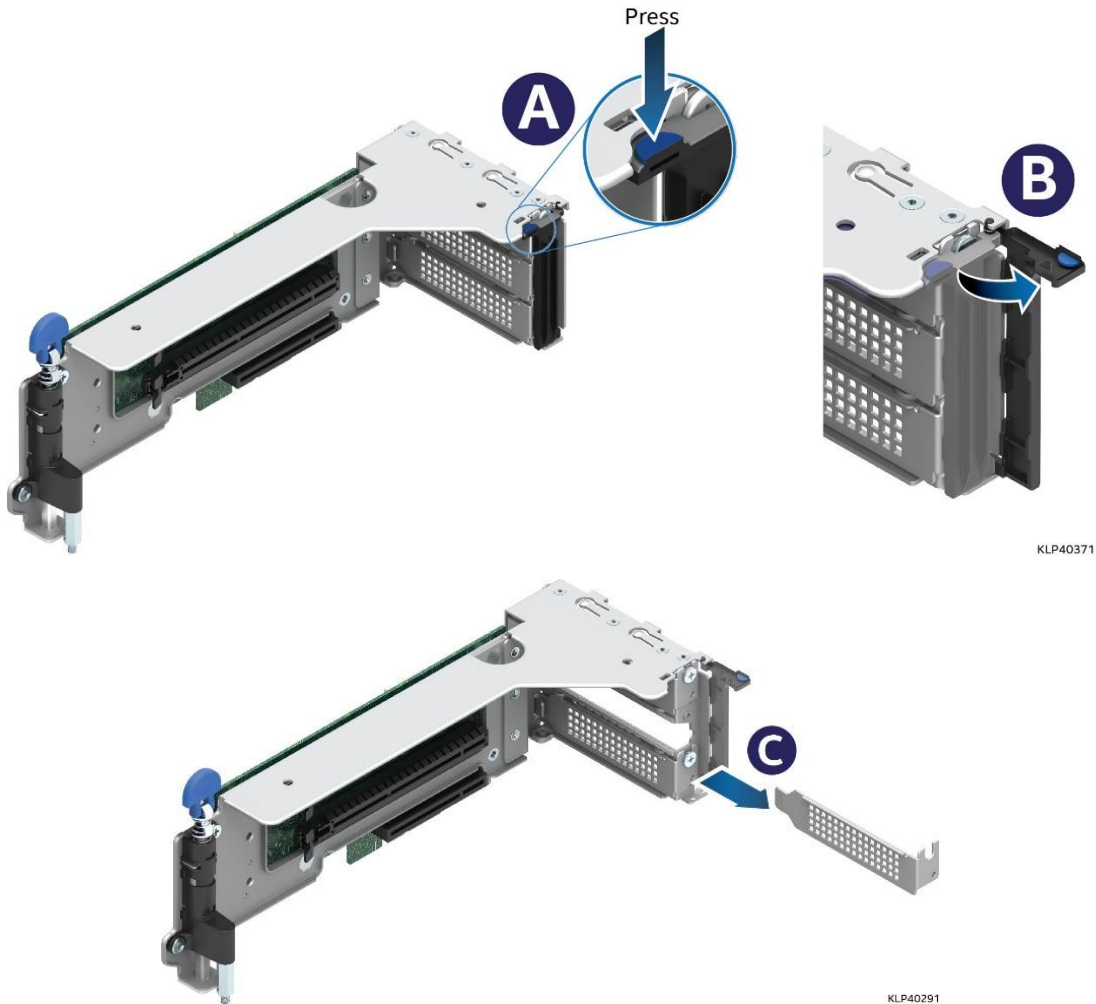
---





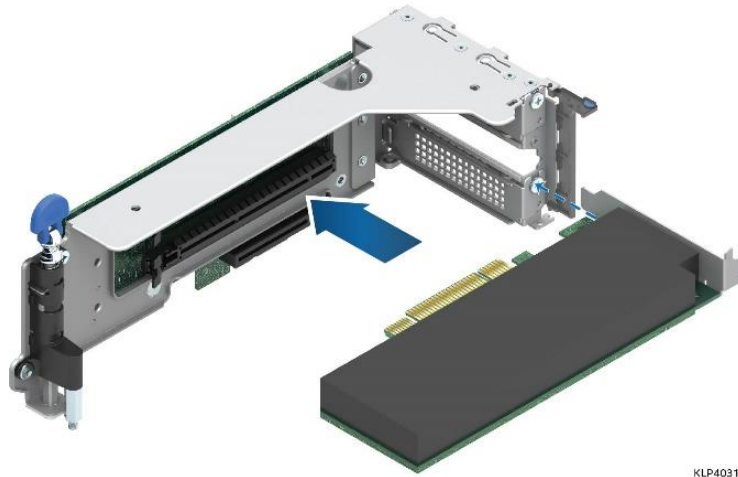
**Figure 36. Riser Card Assembly Removal**

3. Lift the riser assembly from the system (see Letter C).



**Figure 37. Riser Card - Filler Plate Removal**

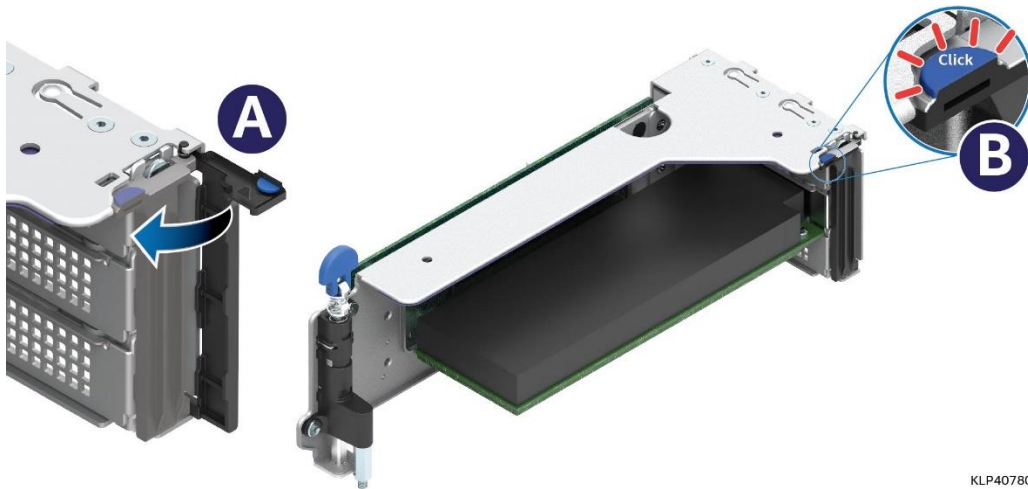
4. Press the blue latch to open the black filler plate retention cover (see Letters A and B).
5. Remove the desired filler plate from the riser bracket (see Letter C).



KLP40311

**Figure 38. Riser Card - Add-in Card Installation**

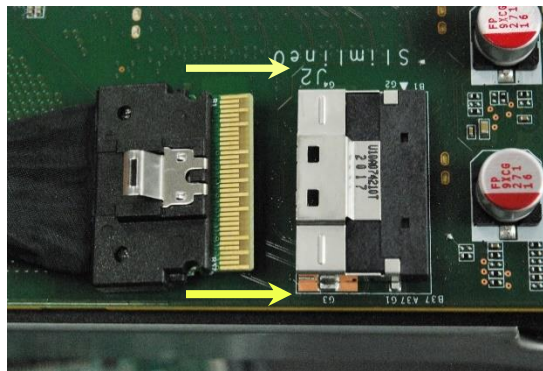
6. Carefully insert the edge connector of the add-in card into the slot on the riser card. Ensure the card is fully seated.



KLP40780

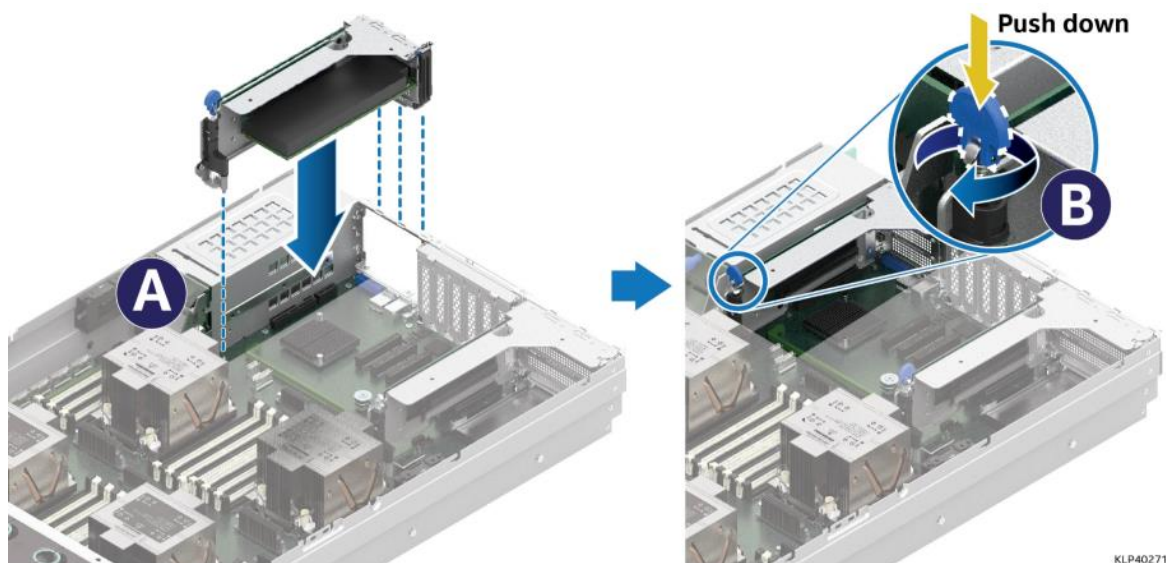
**Figure 39. Riser Card - Close Filler Plate Retention Cover**

7. Close the filler plate retention cover (see Letter A) until it clicks into the locked position (see Letter B).



**Figure 40. Riser Card - Auxiliary PCIe\* Cable Connection**

8. (If present) Reattach all auxiliary PCIe cables to the backside of the riser card. Cables should be locked when fully seated.



**Figure 41. Riser Card Installation into System**

9. Align the back of the riser assembly to the slot guides on the chassis back panel (see Letter A).
10. Carefully lower the riser assembly into the chassis, ensuring the edge connector of the riser card aligns with the riser slot on the server board.
11. Insert the riser card into the slot using even downward pressure until the assembly is fully seated.
12. Push down on the blue tab on the end of the rise assembly and turn it clockwise until the riser assembly is locked in place to the server board (see Letter B).
13. Fold down the blue tab.

---

**Note:** Ensure all internal cables attached to the riser card and/or add-in card are cleanly routed using cable management features. See [Section 2.3](#). Clean cable routing will be necessary to reinstall the air duct.

---

### 3.2.4 PCIe\* Add-in Card Removal – Riser Card

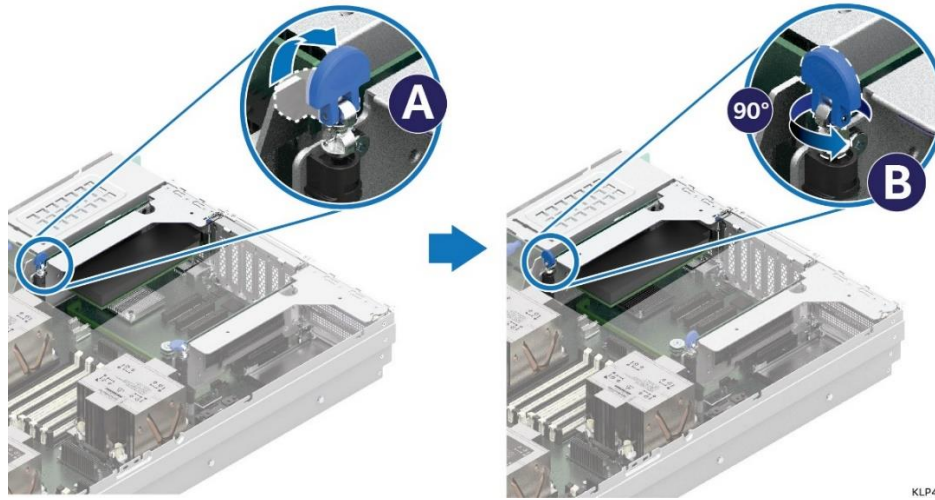
The following illustrations reference the Riser 1 assembly. However, the instructions to add or remove an add-in card is the same regardless of riser card assembly location.

#### Required Tools and Supplies

- Anti-static wrist strap and conductive workbench pad (recommended)

#### System Prerequisites

- The system must be powered off and AC Power cord(s) disconnected
- Disconnect all cables (External and Internal) attached to riser assembly

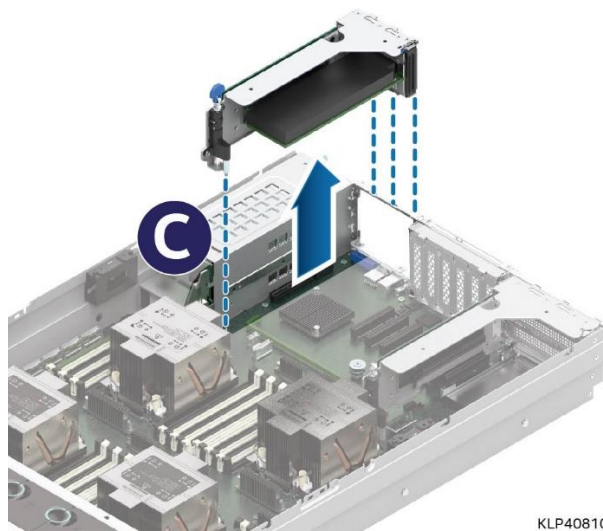
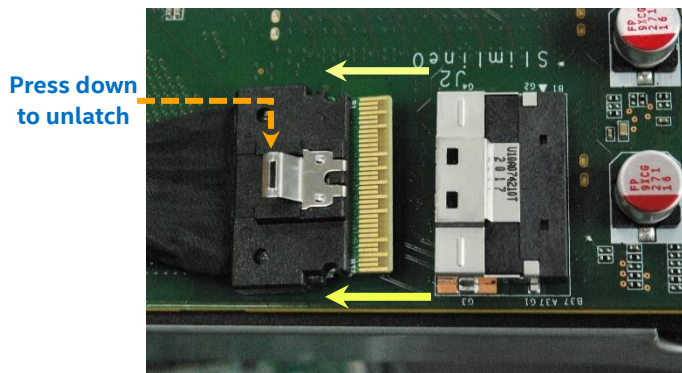


1. Fold up the blue tab located at the end of the riser card assembly (see Letter A).
2. Rotate the blue tab counterclockwise ¼ turn to release the riser assembly from the server board (see Letter B).

---

**Note:** To fully remove the riser assembly from the system, it may be necessary to first disconnect all auxiliary PCIe cables (if present) from the back side of the riser card.

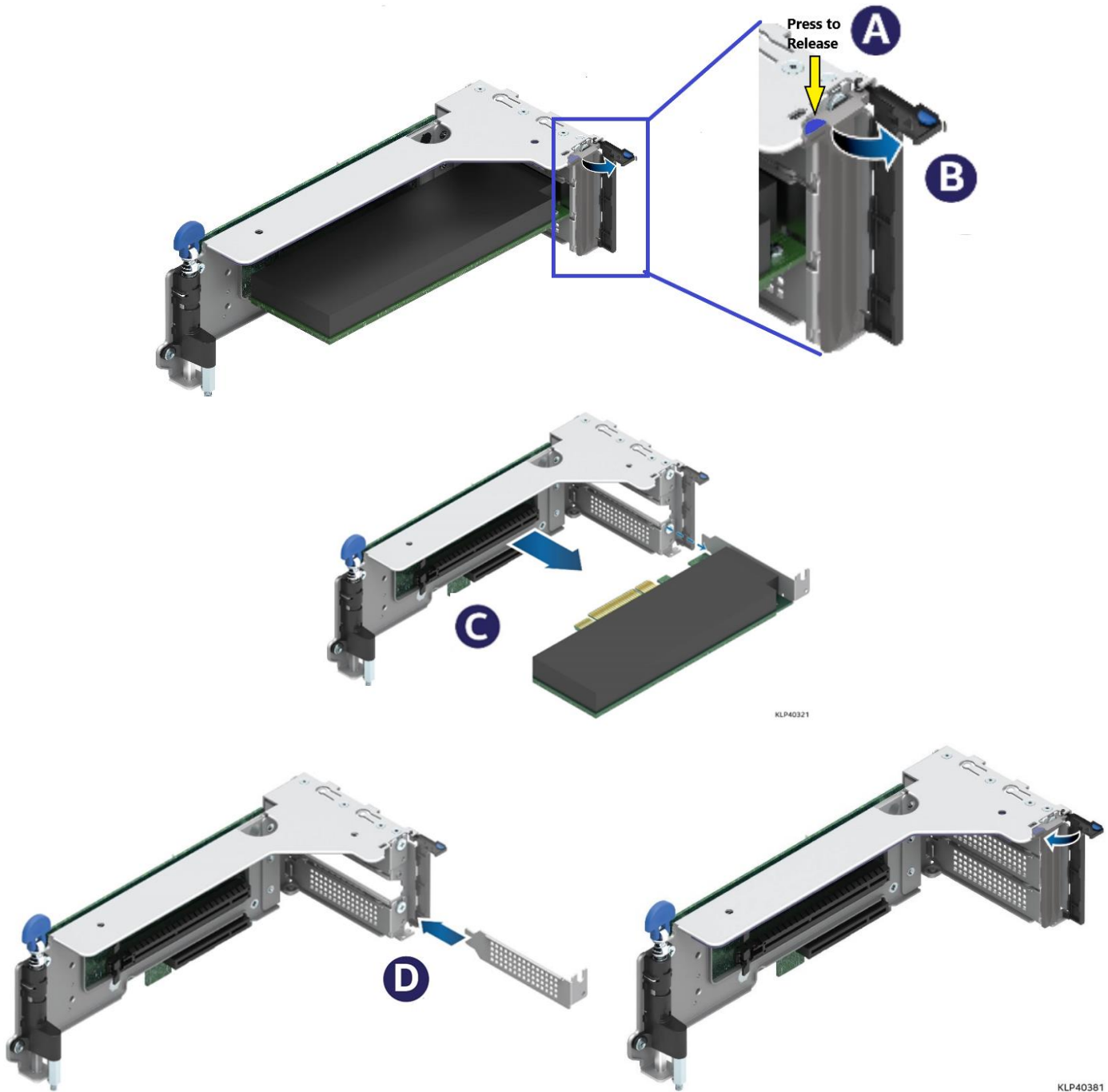
---



**Figure 42. Riser Card Assembly Removal**

3. Carefully lift out the riser assembly from the system (see Letter C).





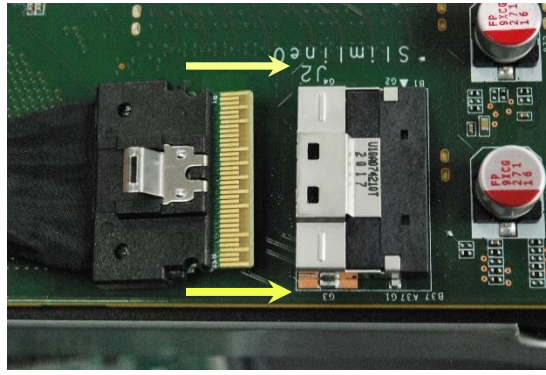
**Figure 43. Add-in Card Removal from Riser Assembly**

1. Press the blue latch to open the black filler plate retention cover (see Letters A and B).
2. Remove the add-in card from riser assembly (see Letter C).
3. Insert filler plate (see Letter D).
4. Close the filler plate retention cover until it clicks into the locked position.

---

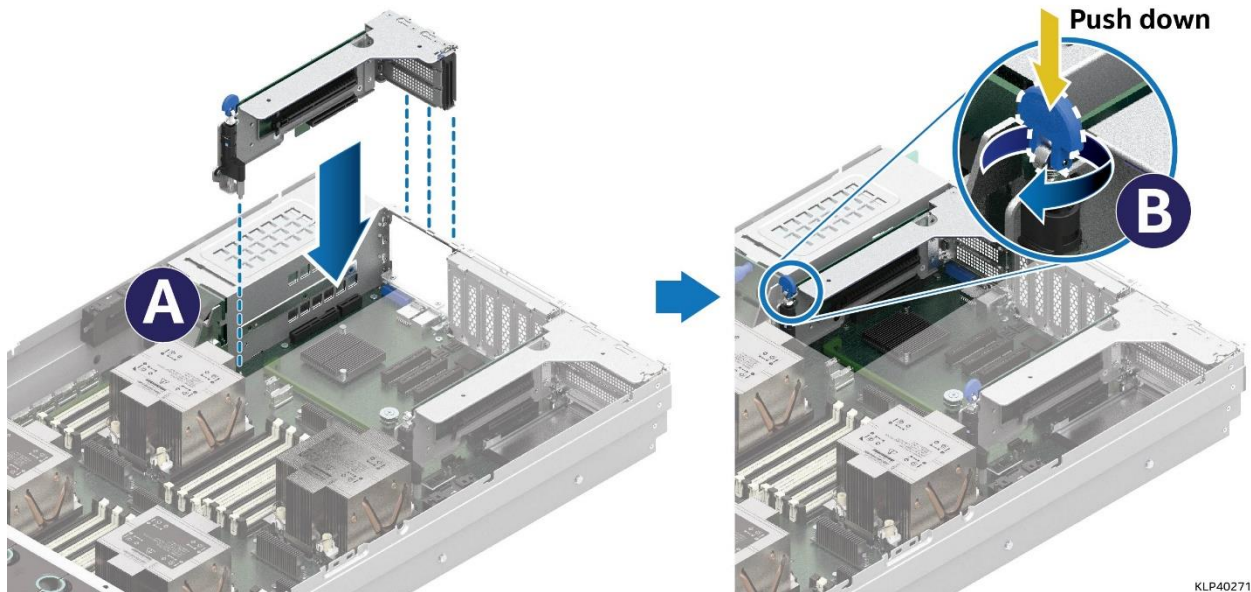
**Note:** All add-in card slots on the back panel of the riser assembly must be populated with an add-in card and back plate or a supplied filler plate. Operating a system with an open back panel slot is not supported and may alter system airflow and/or impact electromagnetic interference (EMI) emission levels generated from the server.

---



**Figure 44. Riser Card - Auxiliary PCIe\* Cable Connection**

5. (If present) Reattach all auxiliary PCIe cables to the backside of the riser card. Cables should be locked when fully seated.



**Figure 45. Riser Card Installation into System**

KLP40271

6. Align the back of the riser assembly to the slot guides on the chassis back panel (see Letter A).
7. Carefully lower the riser assembly into the chassis, ensuring the edge connector of the riser card aligns with the riser slot on the server board.
8. Insert the riser card into the slot using even downward pressure until the assembly is fully seated.
9. Push down on the blue tab on the end of the rise assembly and turn it clockwise until the riser assembly is locked in place with the server board (see Letter B).
10. Fold down the blue tab.

### 3.3 Front 2.5" Drive Installation

The front drive bay may have support for 8, 16, or 24 drive bays. Each drive bay will include a drive carrier that must be populated with a 2.5" drive (SSD or HDD) or supplied drive blank. All drives attached to a common backplane must match media type (SSD or HDD). Mixing drive storage media types within a common backplane is not supported. In addition, all drives attached to a common backplane must share a common interface type (SATA/SAS or NVMe\*).

---

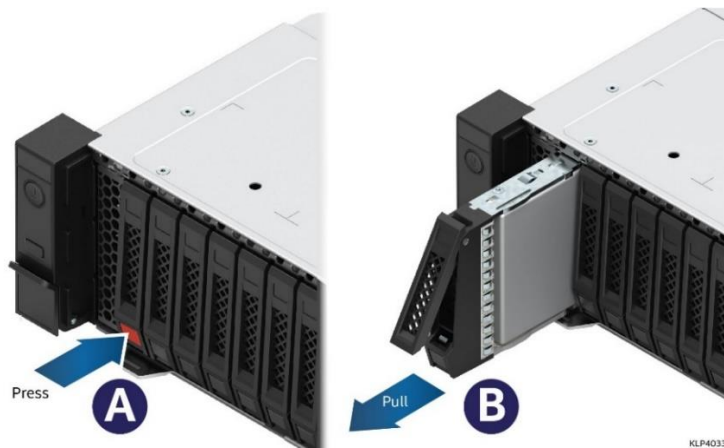
**Note:** To support proper airflow requirements within the system, all drive carriers installed within the front drive bay must be populated with a drive or supplied drive blank insert.

---

Drive carrier removal from the chassis and installation into the chassis is tool-less. However, mounting a drive into the drive carrier requires a Phillips\* head screwdriver.

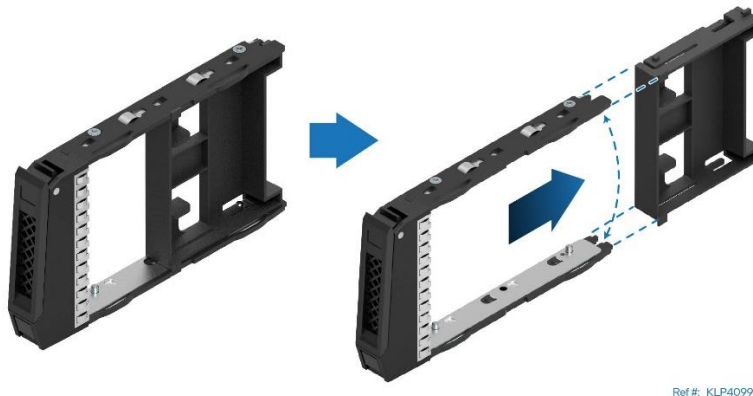
#### Required Tools and Supplies

- Anti-static wrist strap and conductive workbench pad (recommended)
- Phillips head screwdriver



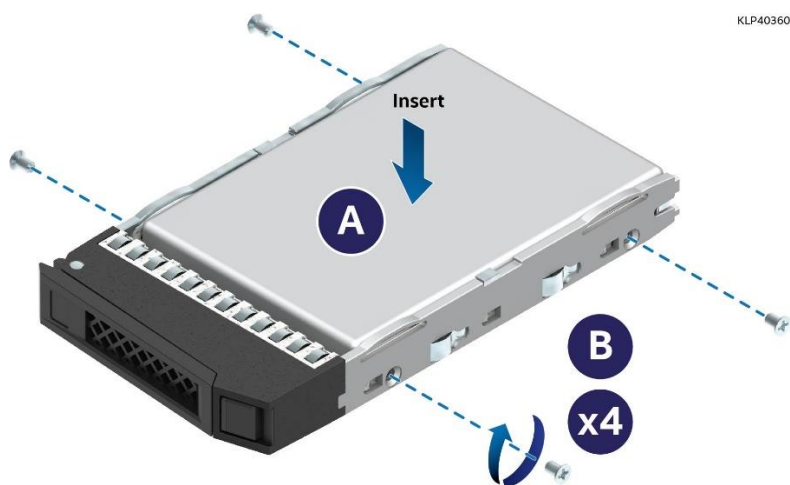
**Figure 46. Front Drive Bay Drive Carrier Removal**

1. Remove the desired drive carrier from the chassis.
  - Push the button to release the drive carrier latch (see Letter A).
  - Using the latch, pull the drive carrier from the drive bay (see Letter B).



**Figure 47. Drive Blank Removal**

2. Remove the drive blank from the drive carrier – No tools required.
  - Gently spread apart the carrier slide rails and slide out the drive blank



**Figure 48. 2.5" Drive Installation to Drive Carrier**

3. Carefully position the drive between the carrier side rails (see Letter A).
4. Ensure all mounting holes on the rails align with those of the drive.
5. Using four (4) screws, fasten the drive to the drive carrier rails (see Letter B).

---

**Note:** Screws to mount a drive to the drive carrier are included and can be found in a bag taped to the drive blank.

---



**Figure 49. Installation of Drive Assembly to Front Drive Bay**

6. Ensure the drive carrier latch is in the outward open position.
7. Carefully push the drive assembly into the drive bay until fully inserted.
8. Close the drive carrier latch to secure the drive to the drive bay.



### 3.4 DDR4 DIMM / Intel® Optane™ PMem Installation

This section describes adding a standard DDR4 DIMM or Intel® Optane™ PMem device to an existing memory configuration. For replacement instructions, see [Section 5.2](#).

DDR4 DIMM and Intel® Optane™ PMem will be commonly referred to as “Memory Module” in the following instructions.

---

**Note:** The system requires that all memory slots be populated with either a memory module or a DIMM blank. Pre-installed DIMM blanks should only be removed when replacing it with an actual memory module. When removing a memory module from the system, it must be replaced with an equivalent device or supplied DIMM blank.

---

#### Required Tools and Supplies

- Anti-static wrist strap and ESD safe workbench

#### System Prerequisites

- The system must be powered off and AC Power cord(s) disconnected
- Remove the system top cover and air duct – See [Section 2.1](#)

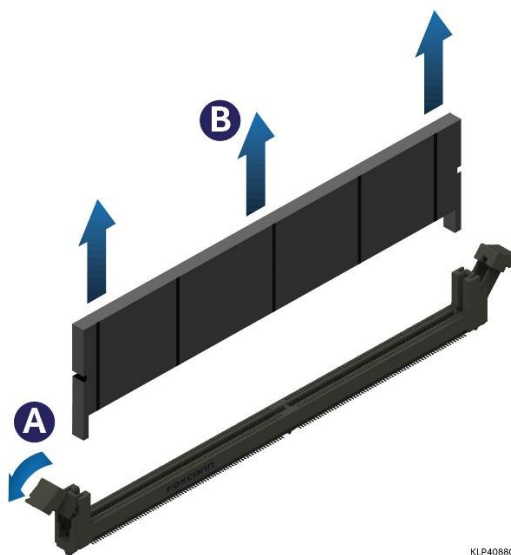
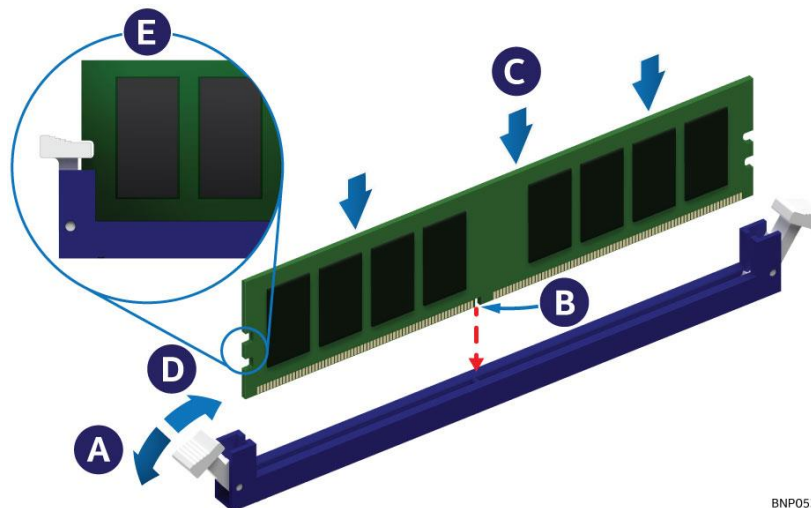


Figure 50. DIMM Blank Removal

1. Remove the DIMM blank from the desired memory slot.
  - Open the ejector tabs at both ends of the selected memory slot to lift the DIMM blank from the slot (see Letter A).
  - Carefully remove the DIMM Blank from the system (see Letter B).



BNP053

**Figure 51. Memory Module Installation**

2. Ensure that the ejector tabs at both ends of the memory slot are pushed outward to the open position (see Letter A).
3. Carefully remove the memory module from its packaging, taking care to only handle it by its outer edges.
4. Align the notch at the bottom edge of the memory module with the key in the memory slot (see Letter B).
5. Insert the memory module into the memory slot.
  - Using even pressure along the top edge, push down on the memory module (see Letter C) until the ejector tabs of the memory slot snap into place (see Letter D).
6. Ensure that the ejector tabs are firmly in place (see Letter E).

---

**Note:** Intel® Optane™ PMem devices require additional steps to enable and configure them. Refer to the appropriate Intel® Optane™ PMem documentation to complete the installation process.

---

### 3.5 Network Adapter for OCP\* 3.0 (Small Form Factor) – Installation / Removal

The system supports one (1) OCP 3.0 (Small form factor) add-in card. Supported OCP 3.0 cards have a pull-tab to remove the card from the system and a thumbscrew to secure it to the system. Other OCP 3.0 small form factor cards that use a latch or internal lock to secure and remove a card from the system are not supported.

An OCP 3.0 card is installed/extracted from an externally accessible OCP card bay on the system back panel directly below the add-in slots for Riser 0.

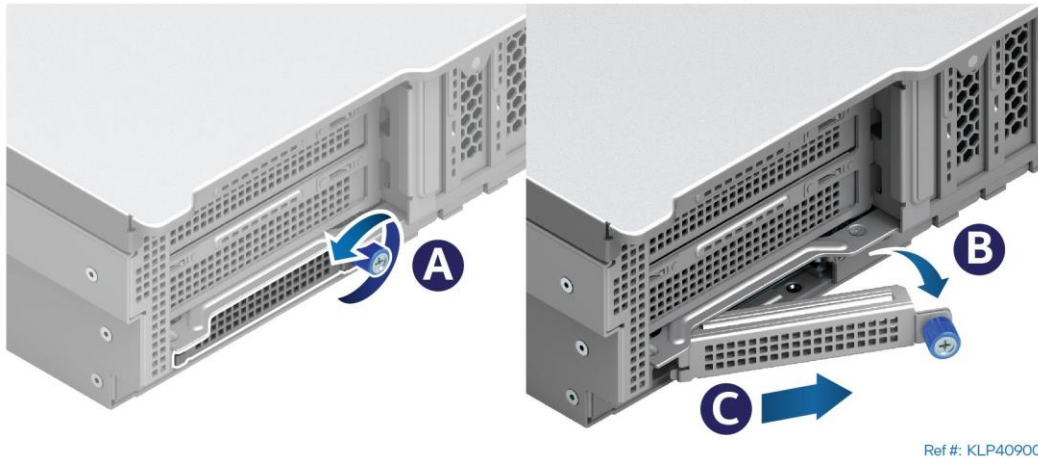
#### Required Tools and Supplies

- Anti-static wrist strap and ESD safe workbench (recommended)
- Phillips\* (cross head) screwdriver #1.

#### System Prerequisites

- The system must be powered off and AC Power cord(s) disconnected

### 3.5.1 Network Adapter for OCP\* 3.0 (Small Form Factor) Installation



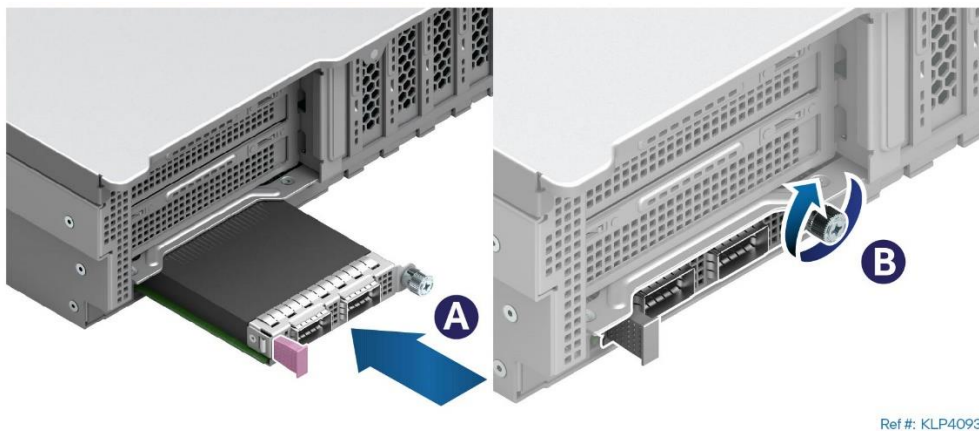
**Figure 52. OCP\* Card Bay Insert Removal**

1. Remove the OCP card bay insert:
  - Loosen the thumb screw on the right side of the insert (see Letter A).
  - Rotate the right side of the insert outward (see Letter B) and pull it from the OCP card bay (see Letter C).

---

**Note:** Retain the OCP card bay insert for future use. The OCP bay must be populated with an OCP 3.0 card or the OCP card bay insert when the system is operational.

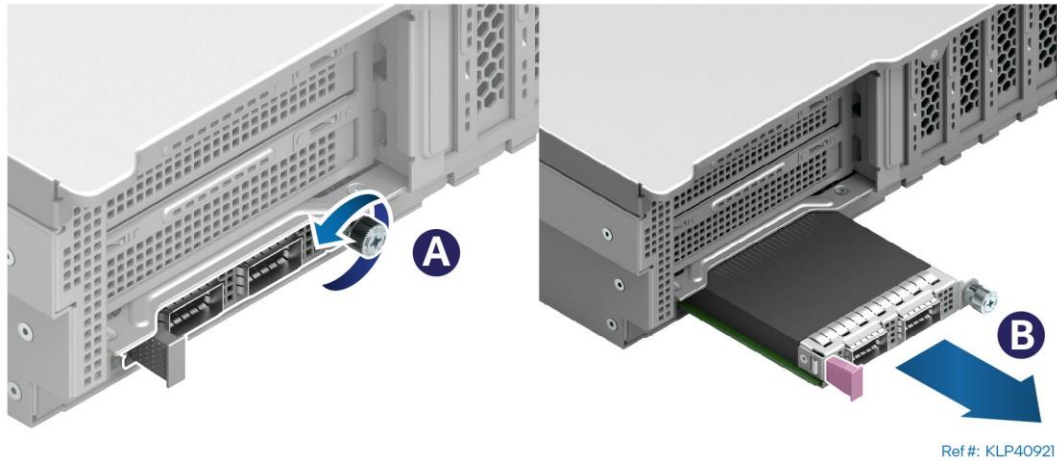
---



**Figure 53. OCP\* Card with Pull-tab Installation**

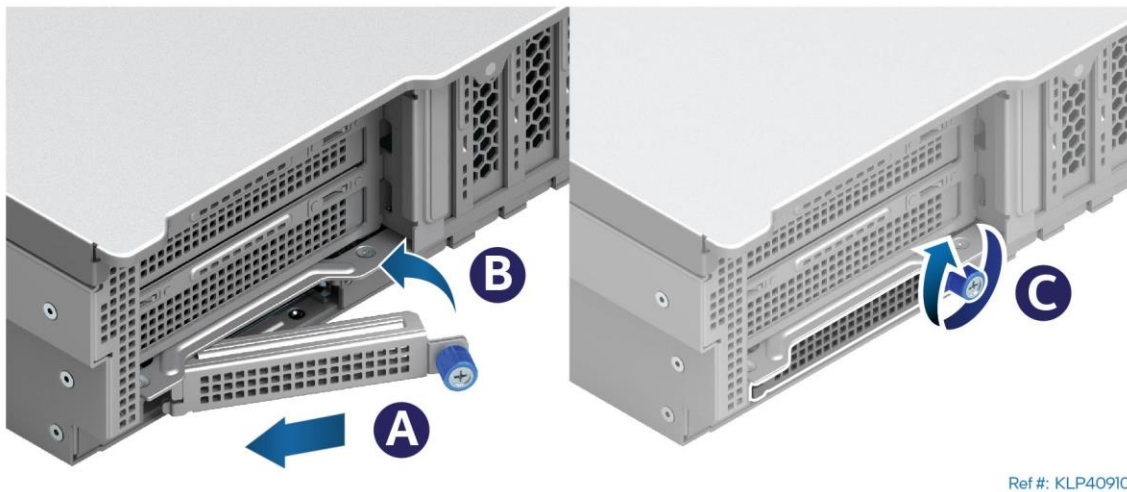
2. Insert the OCP card within the card bay until fully installed (see Letter A).
3. Tighten the thumbscrew to secure the card to the chassis (see Letter B).

### 3.5.2 Network Adapter for OCP\* 3.0 (Small Form Factor) Removal



**Figure 54. OCP\* Card with Pull-tab Removal**

1. Loosen the thumbscrew (see Letter A).
2. Using the pull-tab, pull the OCP card from the chassis (see Letter B).



**Figure 55. OCP\* Bay Insert Installation**

3. (If the OCP card is not being replaced) reinstall the original OCP card bay insert.
  - Latch the left side of the insert to the bay opening (see Letter A) and rotate the insert inward until fully seated (see Letter B).
  - Tighten the thumbscrew (see Letter C).

## 3.6 M.2 Storage Device Installation / Removal

On the system air duct is an M.2 SSD interface board that supports up to two SATA M.2 SSDs. Each connector can support SSDs that conform to a 22110 (110 mm) or 2280 (80 mm) form factor.

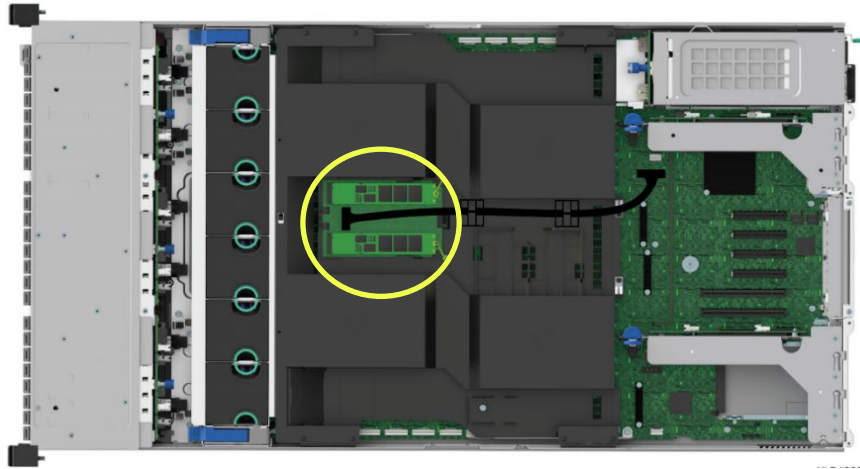


Figure 56. M.2 SSD Interface Board

### Required Tools and Supplies

- Anti-static wrist strap and ESD safe workbench (recommended)

### System Prerequisites

- The system must be powered off and AC Power cord(s) disconnected
- Remove the system top cover – See [Section 2.1](#)

#### 3.6.1 M.2 SSD Installation

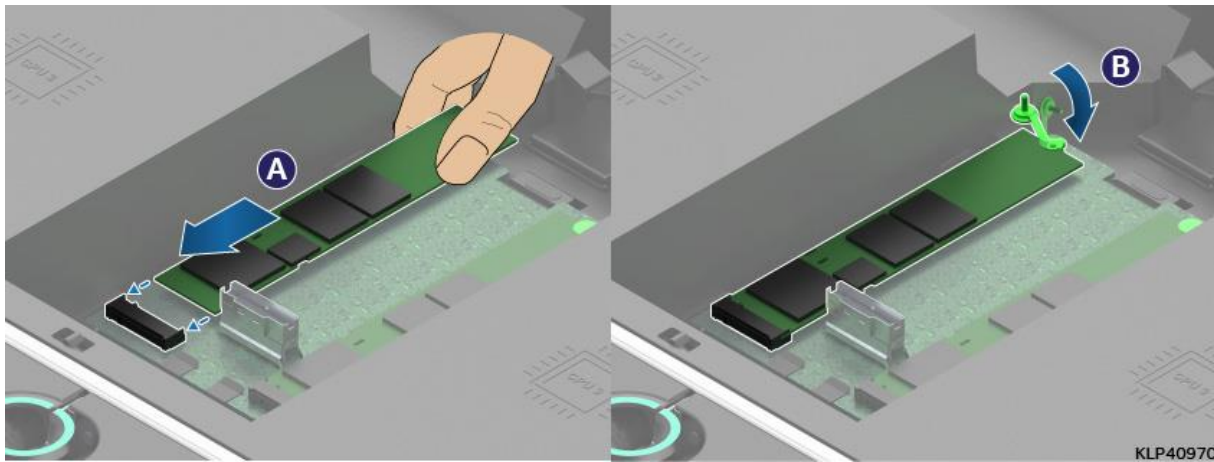


Figure 57. M.2 SSD Installation

1. Slide the M.2 SSD into the M.2 SSD slot (see Letter A).
2. Ensure the notch at the end of the SSD is sitting over the shouldered edge of the lock pin stand-off.
3. Insert the yellow fastener pin into the lock pin stand-off (see Letter B).

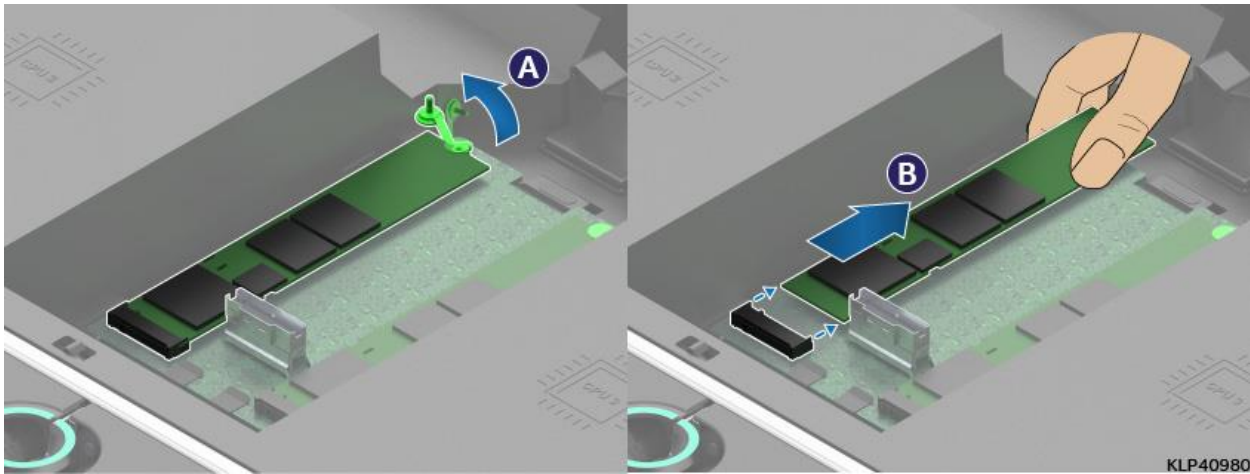
---

**Note:** The lock pin stand-off can be repositioned to accommodate M.2 cards of various lengths.

---



### 3.6.2 M.2 SSD Removal



**Figure 58. M.2 SSD Removal**

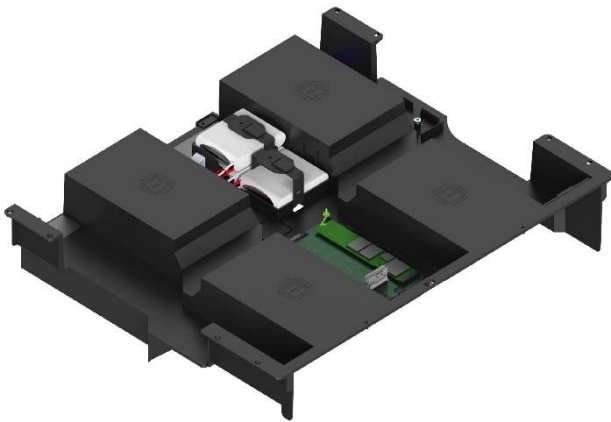
1. Remove the fastener pin from the back edge of the M.2 SSD (see Letter A).
2. Grasp the SSD by its edges and carefully pull it from the M.2 slot (see Letter B).

## 3.7 Intel® RAID Maintenance Free Backup Unit (RMFBU) Installation / Removal

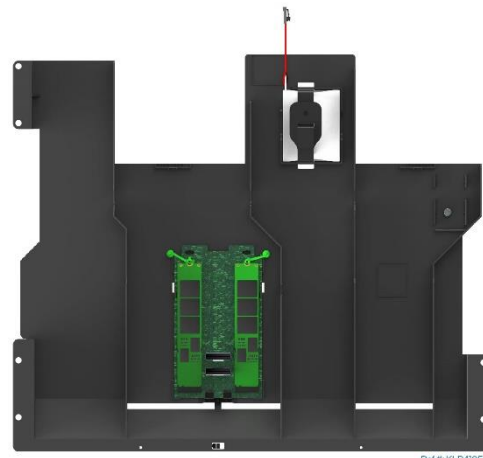
This section provides instructions for the installation and removal of the Intel® RMFBU accessory.

Depending on the system configuration, the Intel® Server System M70KLP supports up to three Intel® RMFBU accessories (Standard System) or one Intel® RMFBU (GPU supported system). In either system configuration, the Intel® RMFBU is mounted to the top side of the system air duct as shown in [Figure 59](#).

To support three RMFBUs in a standard system, two RMFBUs are stacked on top of each other with the third mounted next to them.



**Standard Air Duct**



**GPU Enabled Air Duct**

**Figure 59. Intel® RMFBU Placement**



Intel® RAID Maintenance Free Backup Unit (RMFBU) accessory kits include several components, including a molded plastic mounting bracket. In this system, the mounting bracket is not used.



Figure 60. Intel® RMFBU Accessory Kit

### Required Tools and Supplies

- Anti-static wrist strap and ESD safe workbench (recommended)

### System Prerequisites

- The system must be powered off and AC Power cord(s) disconnected
- RAID Card is installed
- Remove the system top cover – See [Section 2.1](#)

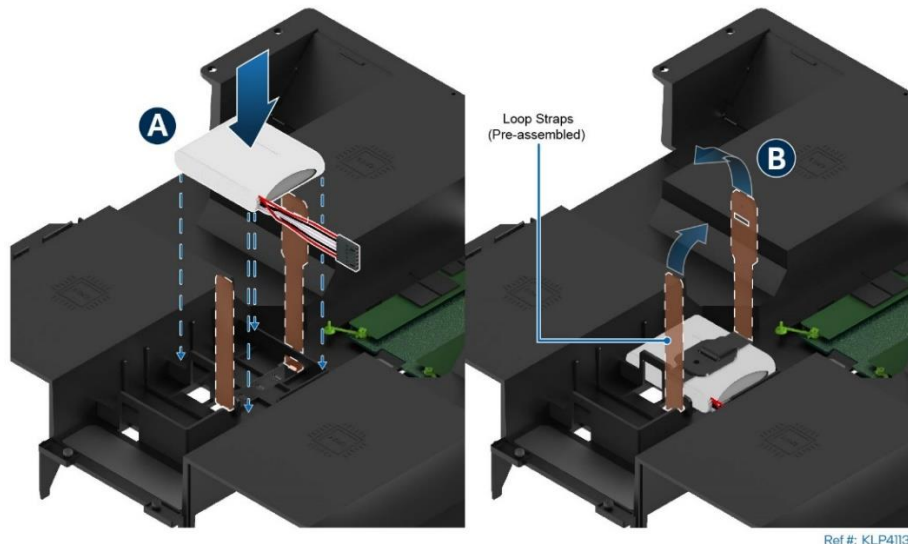
### 3.7.1 RMFBU Installation

Each RMFBU is secured to the top side of the air duct using hook and loop straps pre-mounted to the air duct.

---

**Note:** The Standard air duct supports up to three RMFBUs. Two are stacked together in the mounting location closest to the back edge of the air duct. Securing the stacked RMFBUs is the same as described below.

---

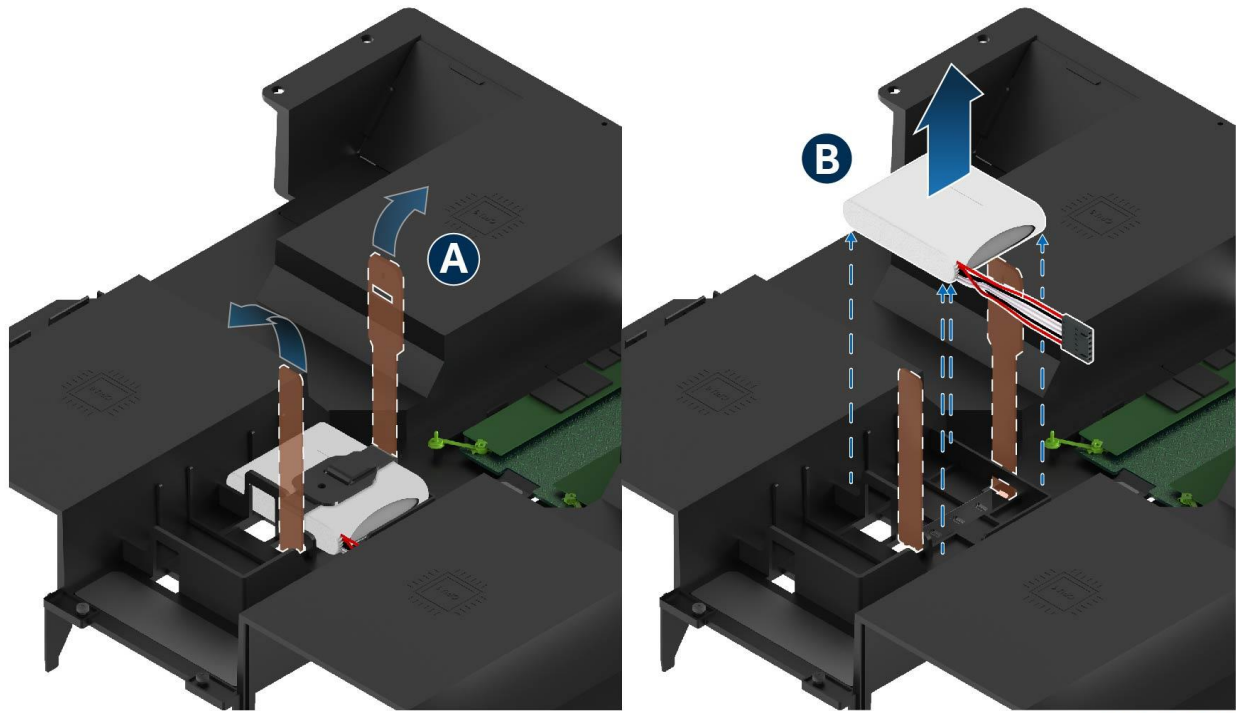


Ref #: KLP41130

Figure 61. Intel® RMFBU Placement

1. Open the pre-installed hook and loop strap on top of the air duct.
2. Position the RMFBU within the designated mounting location on the air duct (see Letter A).
3. Using the hook and loop strap, securely fasten down the RMFBU.
4. Reference the installation procedures that shipped with the RMFBU accessory kit for instructions that describe attaching the RMFBU to the RAID card.

### 3.7.2 RMFBU Removal



Ref #: KLP41140

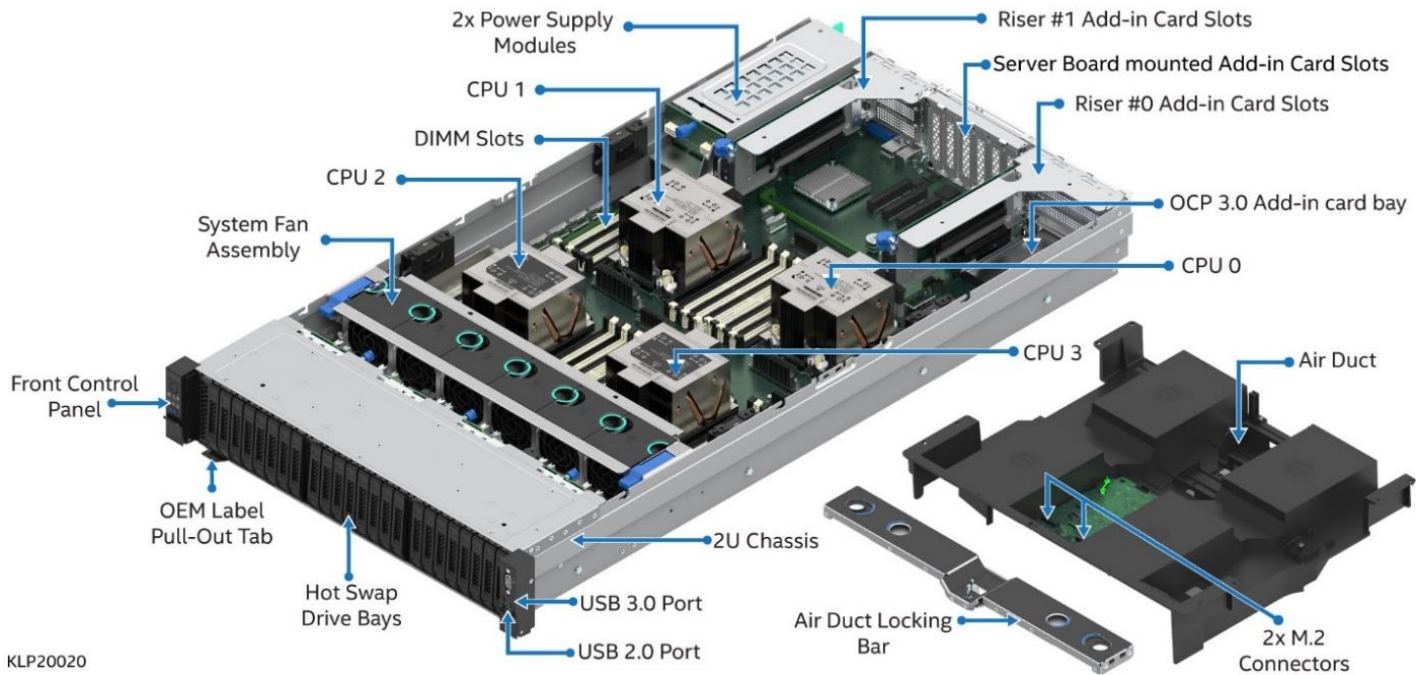
**Figure 62. Intel® RMFBU Removal**

1. Disconnect the RMFBU cable from the RAID Card.
2. Pull open the ends of the hook and loop strap (see Letter A).
3. Lift the RMFBU away from the air duct.

## 4. System Features Overview

This chapter is intended as a system reference for in field service personnel. It provides system views and identifies key system features.

The following illustration identifies system features.



KLP20020

**Figure 63. Common System Features Overview**

**Table 2. System Features Table**

System Options	Standard System - No GPU Support	System with GPU Support
Chassis Form Factor	2U, Rack Mount	
Chassis Dimensions	841 mm x 435 mm x 87 mm	
Processor Support	Up to four (4) 3 <sup>rd</sup> Gen Intel® Xeon® Scalable processor family: Platinum 83xx (H) (HL) Gold 63xx (H) (HL) <ul style="list-style-type: none"> <li>• Four (4) Socket P+ (4189 pin) processor sockets</li> <li>• Up to 28 Cores per processor / Up to 112 Cores per system</li> <li>• Six (6) UPI links per processor</li> <li>• UPI Speeds up to 10.4GT/s</li> </ul> Maximum supported processor TDP: ≤ 250W ** Supported 3 <sup>rd</sup> Gen Intel® Xeon® Scalable processor SKUs must end in (H) or (HL). All other processor SKUs are not supported. ** Previous generation Intel® Xeon® processor and Intel® Xeon® Scalable processor families are not supported	
Chipset	Intel® C621 Chipset	

System Options	Standard System - No GPU Support	System with GPU Support
<b>Memory Support</b>	Up to 48 DIMMs – (12 DIMMs per processor socket) <ul style="list-style-type: none"> <li>• 6 memory channels per processor</li> <li>• 2 DIMM slots per memory channel</li> </ul> DDR4 – RDIMM, RDIMM-3DS, LRDIMM, LRDIMM-3DS Supported Memory Speeds in MT/s : DDR4 SDRAM DIMM Only Configurations <ul style="list-style-type: none"> <li>• Platinum 83xx : 3200 (1 or 2 DPC); 2933 (1 or 2 DPC) (DPC – DIMMs per Channel)</li> <li>• Gold 63xx: 2933 (1 or 2 DPC)</li> </ul> Intel® Optane™ persistent memory 200 Series (App Direct Mode Only) Memory Speeds in MT/s : 2666 (Intel® Optane™ PMem + DDR4 SDRAM configurations)	
<b>PCIe 3.0 Add-in Card Support Options</b>	<ul style="list-style-type: none"> <li>• Up to six (6) onboard (default)</li> <li>• Up to 10 with riser card options</li> <li>• Up to 12 with riser card options + Aux PCIe cabling option</li> </ul>	<ul style="list-style-type: none"> <li>• Up to four (4) onboard +</li> <li>• Up to four (4) with riser cards                             <ul style="list-style-type: none"> <li>○ 2 x GPU – (FH, FL, DW)</li> <li>○ 2 x PCIe X8 – (FH, HL) with Aux PCIe cabling option</li> </ul> </li> </ul>
<b>Network Support Options</b>	OCP 3.0 Add-in card options: <ul style="list-style-type: none"> <li>• See product family Tested Hardware list for supported options.</li> </ul>	
<b>Front Access Drive Bay support</b>	8, 16, or 24 Hot Swap Drive Bays <ul style="list-style-type: none"> <li>• 2.5" SSDs or HDDs</li> <li>• SAS, SATA, NVMe</li> </ul>	8 Hot Swap Drive Bays <ul style="list-style-type: none"> <li>• 2.5" SSDs or HDDs</li> <li>• SAS, SATA, NVMe</li> </ul>
<b>Internal M.2 SSD support</b>	Up to two (2) internal mount M.2 SATA SSDs <ul style="list-style-type: none"> <li>• 2280 and 22110 form factors supported</li> </ul>	Up to two (2) internal mount M.2 SATA SSDs <ul style="list-style-type: none"> <li>• 2280 and 22110 form factors supported</li> </ul>
<b>Rear Panel Features</b>	<ul style="list-style-type: none"> <li>• One (1) Rear Access OCP Add-in card bay</li> <li>• One (1) OCP slot power button for hot swap support – (NOT SUPPORTED)</li> <li>• Two (2) USB 3.0 Ports</li> <li>• One (1) VGA Connector</li> <li>• One (1) RJ45 Dedicated Management Port</li> <li>• One (1) 3.5mm Serial Port interface connector – (NOT SUPPORTED)</li> <li>• One (1) 3.5mm BMC Serial Port interface connector – (NOT SUPPORTED)</li> <li>• One (1) UID Button/LED</li> <li>• One (1) System Reset Button</li> <li>• One (1) Rear Access Dual Power Supply Module Bay</li> </ul>	
<b>Front Control and I/O Panel Features</b>	Left Front Control Panel Features <ul style="list-style-type: none"> <li>• System Power Button / LED</li> <li>• UID Button / LED</li> <li>• Various system feature/status LEDs</li> </ul> Right Front I/O Panel Features <ul style="list-style-type: none"> <li>• VGA Connector</li> <li>• One (1) USB 3.0 Connector</li> <li>• One (1) USB 2.0 Connector</li> </ul>	
<b>Power Supply Options</b>	Up to two (2) CPRS power supply modules 1+1 Redundancy (hot swappable) 2+0 Combined Power (No power redundancy) Options: <ul style="list-style-type: none"> <li>• AC 2000W (80-Plus Platinum)</li> </ul>	Up to two (2) CPRS power supply modules 1+1 Redundancy (hot swappable) 2+0 Combined Power (No power redundancy) Options: <ul style="list-style-type: none"> <li>• AC 2000W (80-Plus Platinum)\</li> </ul>
<b>System Cooling Features</b>	<ul style="list-style-type: none"> <li>• Six (6) managed 60x60x56mm System Fans with support for fan redundancy</li> <li>• One Fan per installed Power Supply</li> <li>• Four (4) 2U CPU Heat Sinks</li> <li>• Standard Air duct</li> </ul>	<ul style="list-style-type: none"> <li>• Six (6) managed 60x60x56mm System Fans with support for fan redundancy</li> <li>• One Fan per installed Power Supply</li> <li>• Four (4) 1U CPU Heat Sinks</li> <li>• Low Profile Air Duct</li> </ul>
<b>Management Support</b>	<ul style="list-style-type: none"> <li>• One (1) Dedicated RJ45 1Gb Management Port (Back Panel)</li> <li>• IPMI 2.0</li> <li>• Red Fish</li> <li>• Integrated BMC Web Console</li> </ul>	

System Options	Standard System - No GPU Support	System with GPU Support
<b>Serviceability Features</b>	Tool-less (Removal / Installation) <ul style="list-style-type: none"> <li>• Top Cover</li> <li>• PCIe add-in cards and OCP 3.0 Add-in card</li> <li>• System Fans – Hot Swappable</li> <li>• System Fan Housing</li> <li>• Front Drive Bay Backplane(s)</li> <li>• Power Distribution Board</li> <li>• Power Supply Module(s) – Hot swappable in 1+1 redundant configuration</li> <li>• Front Mount Drives – Hot Swappable in fault tolerant RAID configurations.                             <ul style="list-style-type: none"> <li>○ Screws required to mount drive to drive carrier</li> </ul> </li> </ul>	
<b>Operating Ambient Temperature Support</b>	<ul style="list-style-type: none"> <li>• 10 – 35° C ambient temperature</li> </ul>	
<b>Security</b>	TPM 2.0 Option (Rest of the world) - <b>iPC KLTPM</b> - Note: China only TPM not supported Intel® Platform Firmware Resilience (Intel® PFR) Converged Boot Guard and Intel® Trusted Execution (Intel® TXT)	
<b>Rack Mount Kit (Included)</b>	Rack mount rails Tool-less attachment to chassis and rack installation Full extension from rack 38 Kg max supported weight	

The system may have support for 8, 16, or 24 front drive bays. Each drive bay will include a drive carrier that must be populated with a drive (SSD or HDD) or supplied drive blank. All drives attached to a common backplane must match media type (SSD or HDD). Mixing drive storage media types within a common backplane is not supported. In addition, all drives attached to a common backplane must share a common interface type (SATA/SAS or NVMe\*).

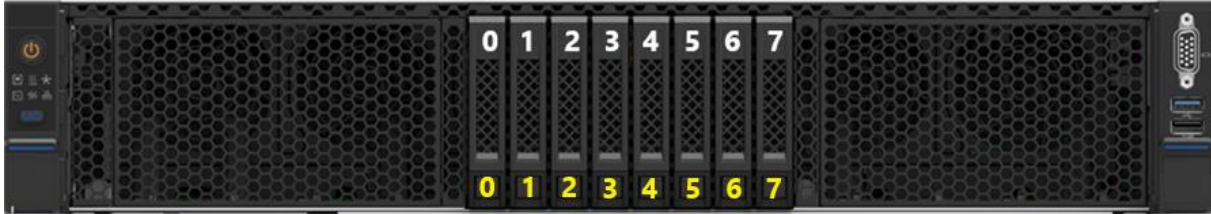


Figure 64. 8 x2.5" SSD Front Drive Bay Configuration

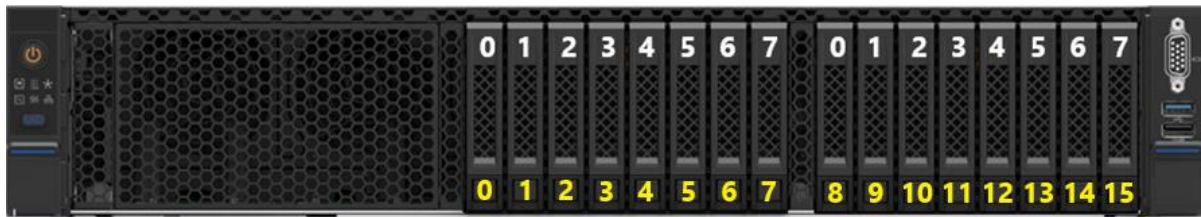


Figure 65. 16 x2.5" SSD Front Drive Bay Configuration



Figure 66. 24 x2.5" SSD Front Drive Bay Configuration



Integrated within the front system handles are a control panel (Left) and I/O panel (Right), as shown below.

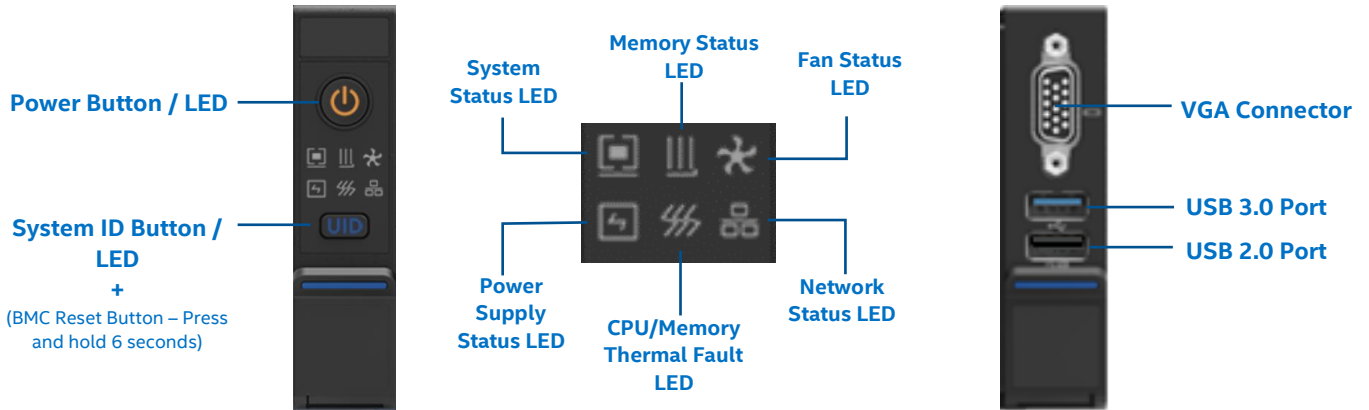


Figure 67. Front Control and I/O Panels

Table 3. Front Panel Button and LED Operation

Button / LED	Description
Power button with LED	The power LED is green when power is on.
	The power LED is orange when the system is in standby.
	Press the button for 4 seconds to force a system shutdown.
Unit ID Button with LED / BMC RST button	The button is used to turn on/off the Blue UID LED.
	Press and hold the button for 6 seconds to force the BMC to restart.
System fault indicator	LED is OFF when system is in a normal state
	LED is steady RED if the system is in a fault condition.
	LED will Blink RED when an alarm is reported.
Memory fault indicator	LED is OFF when system is in a normal state
	LED is steady RED if memory is in a fault condition.
	LED will Blink RED when an alarm is reported.
Fan fault indicator	LED is OFF when system is in a normal state
	LED is steady RED with a fan RPM read failure.
	LED Blinks RED in the case of RPM read exception.
Power supply fault indicator	LED is OFF when system is in a normal state
	LED Is steady RED when a power supply fails.
	LED Blinks RED when the power supply is abnormal.
CPU / Memory thermal fault indicator	LED is OFF when system is in a normal state
	LED is steady RED when the CPU or memory is overheated.
Network status LED	LED is steady green or blinks green when the network connection is normal.
	LED Is off in the case of no network connection.
	*Note: It only indicates the working status of the OCP card (4S).



On the bottom edge of each front mounted 2.5" drive carrier are LEDs for Drive Activity and Drive Fault.

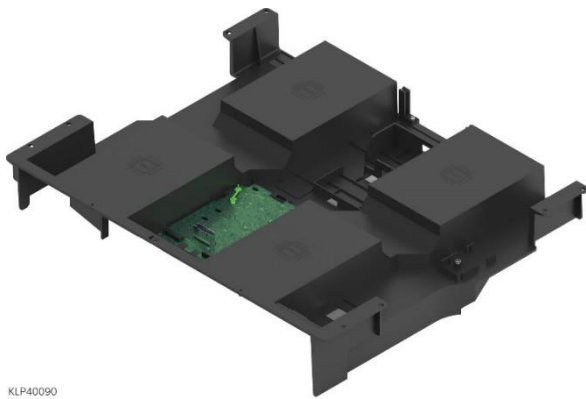


Label	Description	Description
1	Activity Status LED	Steady green: Normal Flashing green: Read and write activity
2	Fault Alarm LED	Steady red: A failure has occurred Steady blue: Drive positioning Steady pink: RAID rebuilding

**Figure 68. 2.5" Hot Swap Drive LED Identification**

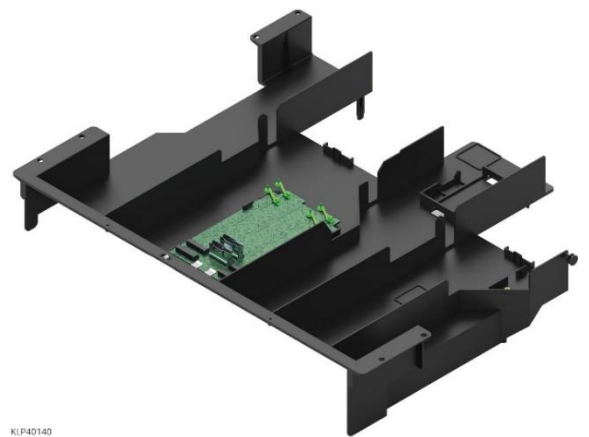
The Standard and GPU Enabled systems will each include an air duct designed to meet the specific airflow and features requirements of the system.

**Standard Air Duct**



KLP40090

**Low Profile Air Duct (GPU Systems Only)**



KLP40140

**Figure 69. Air Duct Options**

The Standard air duct will accommodate 2U processor heat sinks and allow support for up to six (6) half height / half-length PCIe add-in cards on the server board, three (3) full-height/half-length PCIe add-in cards from Riser #0 and up to three (3) half-height/half-length PCIe add-in cards from Riser #1. The top side of the air duct has mounting features for an M.2 interface board capable of supporting up to two (2) SATA M.2 SSDs, and support for up to three (3) Intel® RAID Maintenance Free Backup (RMFBU) modules.

The low-profile air duct used in the GPU enabled system option will accommodate 1U processor heat sinks and allow support for four half-height/half-length PCIe add-in cards on the server board, one (1) GPU add-in card (Full-Height Full-Length Double-wide) + one (1) Full-Height Half-Length PCIe add-in card from each riser card assembly. The top side of the air duct has mounting features for an M.2 interface board capable of supporting up to two (2) SATA M.2 SSDs, and support for one (1) Intel® RAID Maintenance Free Backup (RMFBU) module.

The following illustrations identify the features found on the back panel for both the Standard and GPU enabled system options. All I/O connectors, buttons, LEDs, OCP support, and power supply bays will be common between the two system options.

The base Standard system option includes support for up to six (6) server board mounted PCIe\* Gen3 add-in cards. Riser card options adds support for an additional six (6) PCIe Gen 3 add-in cards<sup>1</sup>.

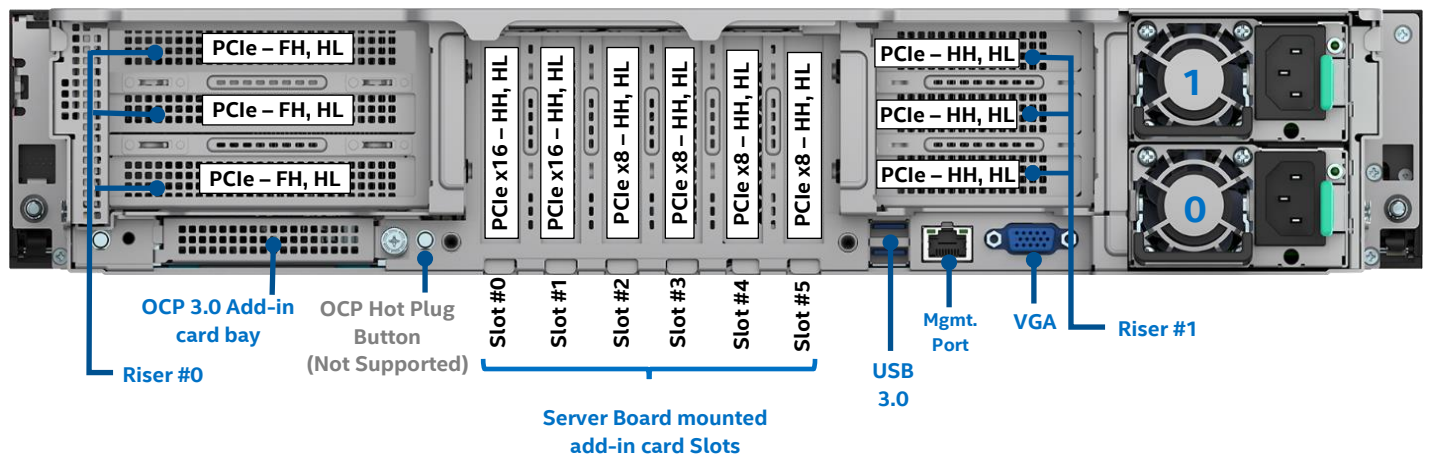


Figure 70. Standard System - Back Panel Features

The GPU enabled system option supports up to four (4) server board mounted PCIe Gen 3 add-in cards. With two PCIe riser cards, the system will also support up to two (2) Full-Height Full-Length Double-Wide GPU add-in cards + two (2) Full-Height Half Length PCIe Gen 3 add-in cards<sup>1</sup>.

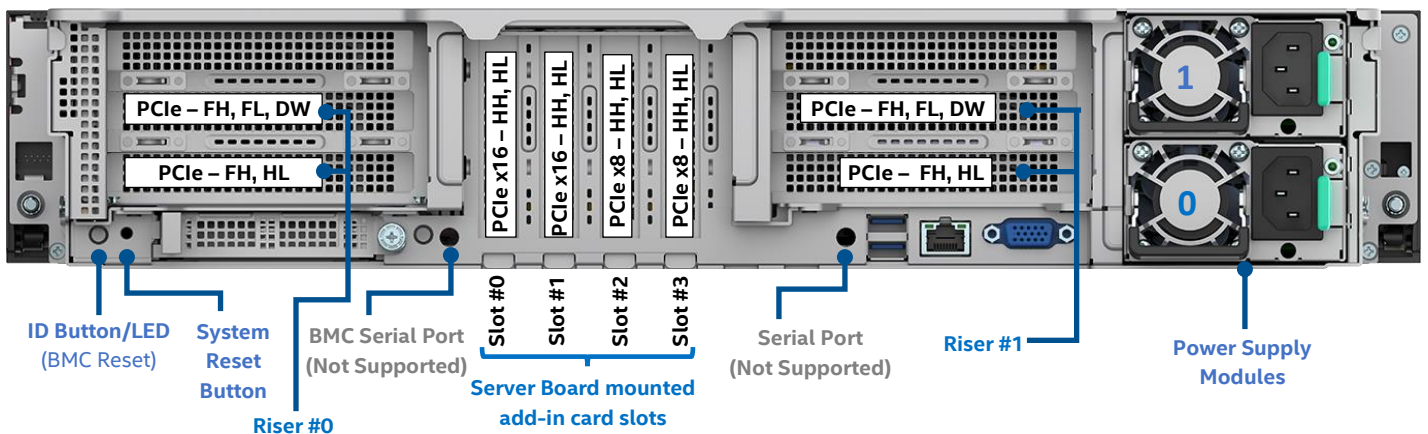


Figure 71. GPU Enabled System - Back Panel Features

<sup>1</sup> Some riser card add-in slots require that PCIe bus lanes be cabled to the riser cards from one or more of the PCIe slim-line connectors on the server board.

The Intel® Server System M70KLP supports two AC 2000 Watt (80-Plus Platinum) hot-swap capable power supply modules. Supported power supply operating modes include: 1+1 Redundant and 2+0 combined power.



**Figure 72. 2000W Power Supply Module**

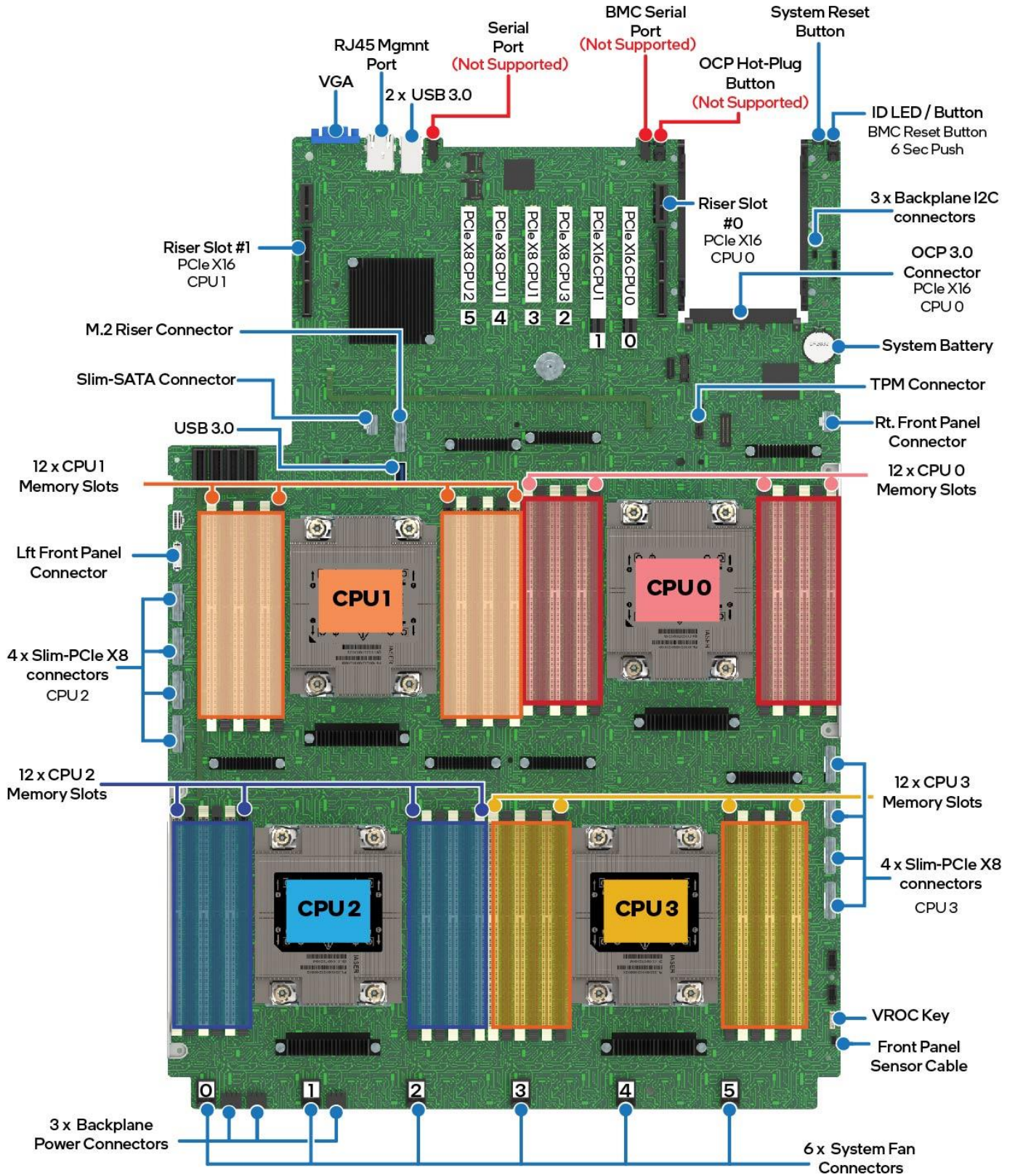
---

**Important Note:** All integrated L9 system configurations from Intel will draw greater than 1000W of power when running medium to heavy workloads. To support this power requirement, systems must be connected to a 220V AC input power source to operate. A system running a medium to heavy workload and is connected to a 110V AC input power source will not operate correctly.

---



Integrated within the server system is the Intel® M70KLP server board. The following illustration identifies the supported features and available system option interconnects.



Ref #: KLPI0013

Figure 73. Server Board Features

## 5. FRU Replacement

---

This chapter provides instructions for the replacement of system components considered to be field replaceable (FRU). Only system features that are identified as hot-swappable can be replaced while the system remains operational. These include:

- Power Supply – Dual power supply 1+1 redundant configurations only
- Drives mounted within the front drive bay – Fault Tolerant RAID (1, 5, 6, and 10) configurations only
- System Fans

All other components within the system can only be serviced after the system has been powered off and AC power cords have been disconnected from the server system.

All procedures documented in this chapter include an “Average Time to Complete” the procedure. The service time is measured from the moment the system top cover is removed to the time the top cover is reinstalled. Or for component replacement that does not require top cover removal, the time the component is removed from the system to the time it is reinstalled.

Intel recommends that all system service procedures be performed by a qualified service technician.

### Before You Begin

Before replacement of any system components, review all the safety and ESD precautions found in the Safety Warnings section at the beginning of this document.

### System Reference

In the following procedures, all references to left, right, front, top, and bottom assume the reader is facing the front of the server chassis.

### Instruction Format

Each procedure described in this chapter follows an illustration first format. This format gives the reader the option to follow a quicker path to completing the objective by first seeing an illustration of the intended procedural step or steps. If necessary, the reader can follow the step-by-step instructions that follow each illustration.

### Warranty Replacement Packaging

For warranty replaced components, save, and reuse all packaging the replacement component came in when sending the failed component back to Intel.

### Top Cover and Air Duct Removal / Installation

Most procedures documented in this chapter will require access to the inside of the system. If necessary, instructions to remove and reinstall the system top cover and system air duct can be found in Chapter 2 of this document.

## 5.1 System Fan Replacement

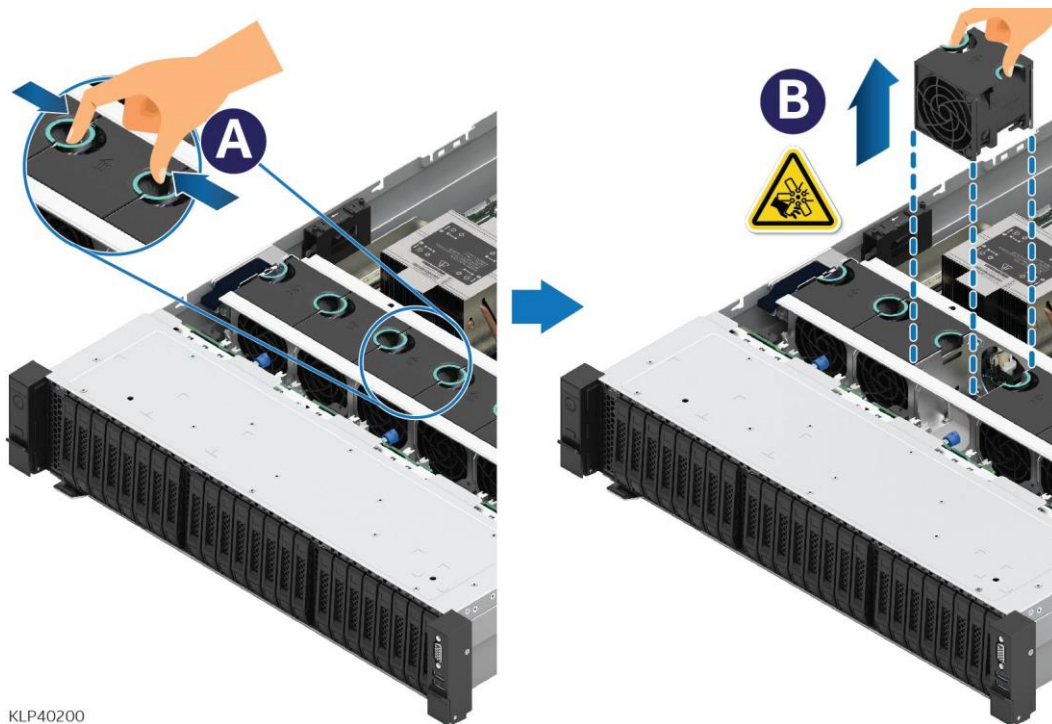
### Required Tools and Supplies

- Anti-static wrist strap and other anti-ESD precautions (recommended)
- No tools are required to replace a faulty system fan
- Replacement system fan

**Average Time to Complete:** < 3 minutes

### Procedure Prerequisites

- System fans are identified 0 – 5. Using fan fault information obtained via the system event log (SEL) or other system management software, identify the system fan number to be replaced.
- It is recommended that the system be powered down and unplugged from the AC power source before replacing a faulty system fan. However, system fans are hot-swappable. If necessary, the following procedure can be performed while the system is still operational. To ensure system thermals stay within required operational limits, the procedure must be completed and the top cover reinstalled as quickly as possible.
- Remove system top cover (see [Section 2.1.1](#)).



**Figure 74. Individual Fan Removal or Installation**

1. Identify and locate the faulty fan and ensure the rotor is NOT spinning.

---

**Caution:** System fans operate at very high speeds and can be harmful if removed from the system while the rotor is still turning. To prevent possible personal injury, a system fan must be deemed non-functional with the rotor not turning before removing it from the system.

---

2. Using the finger grips on top of the fan, grasp the faulty system fan and pull it up from the fan housing.



3. Locate and unpack the replacement fan.

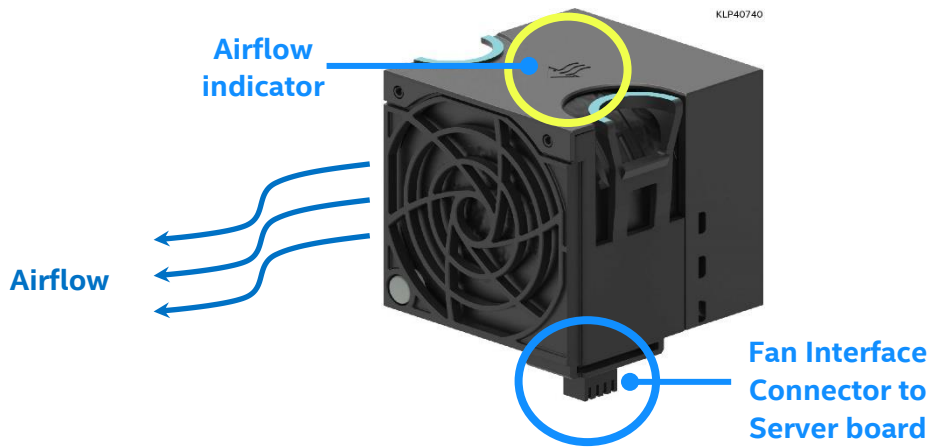


Figure 75. System Fan

4. Orient the fan so the arrow on top of the fan points to the back of the system.

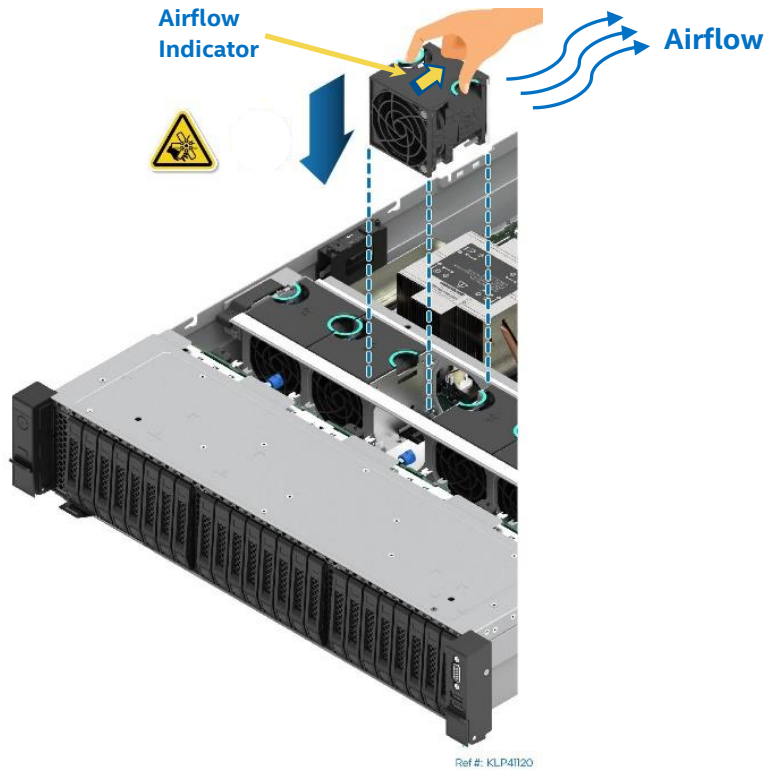


Figure 76. System Fan Placement

5. Gently squeeze together the finger grips atop of the fan and insert it into the fan housing.
6. Push down on the fan until fully seated and release it. The fan should be locked in place.
7. Reinstall the system top cover (see [Section 2.2.2](#)).

## 5.2 DIMM / Intel® Optane™ PMem Replacement

### Required Tools and Supplies

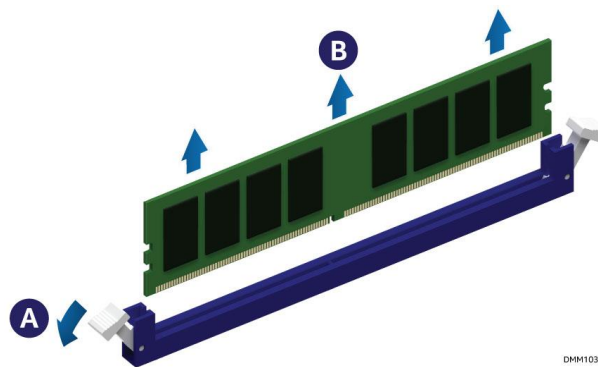
- Anti-static wrist strap and conductive workbench pad (recommended)
- Replacement equivalent memory module

**Average Time to Complete:** ~ 5 minutes (Full Intel® Optane™ PMem replacement and setup will be longer)

### Procedure Prerequisites

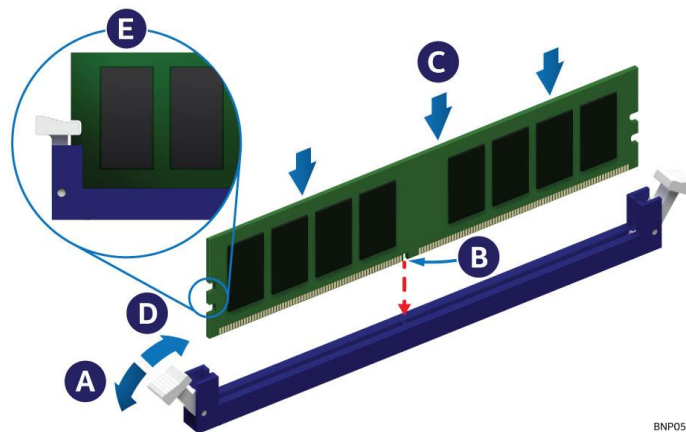
- Memory modules are NOT hot-swappable. The system must be powered down and unplugged from the AC power source before replacing a faulty memory module from the system.
- Remove the system top cover and system air duct – See [Sections 2.1.1](#) and [2.1.2](#).

Instructions to physically replace a DDR4 DIMM or an Intel® Optane™ PMem 200 series module are the same. For the following procedure, Standard DDR4 DIMMs and Intel® Optane™ PMem devices are commonly referred to as “Memory Module”



**Figure 77. Memory Module Removal**

1. Identify and locate the faulty memory module.
2. Ensure that the ejection tabs of adjacent memory slots are fully closed.
3. Open the ejection tabs at both ends of the selected memory slot (see Letter A). The memory module will lift out from the memory slot.
4. Holding the memory module by its edges, lift it away from the slot (see Letter B).



**Figure 78. DIMM Installation**

5. Ensure that the ejection tabs at both ends of the memory slot are pushed outward to the open position (see Letter A).
6. Carefully unpack the replacement memory module, taking care to only handle the device by its outer edges.

7. Align the notch at the bottom edge of the memory module with the key in the memory slot (see Letter B).
8. Insert the memory module into the memory slot.
  - Using even pressure along the top edge, push down on the memory module (see Letter C) until the ejection tabs of the memory slot snap into place (see Letter D).
9. Ensure that the ejection tabs are firmly in place (see Letter E).
10. Reinstall the system air duct and top cover (see [Sections 2.2.1](#) and [2.2.2](#)).

---

**Note:** Replacing Intel® Optane™ PMem devices requires additional steps to enable and configure them. Refer to the appropriate Intel® Optane™ PMem documentation to complete the installation process for these devices.

---

## 5.3 System Battery Replacement

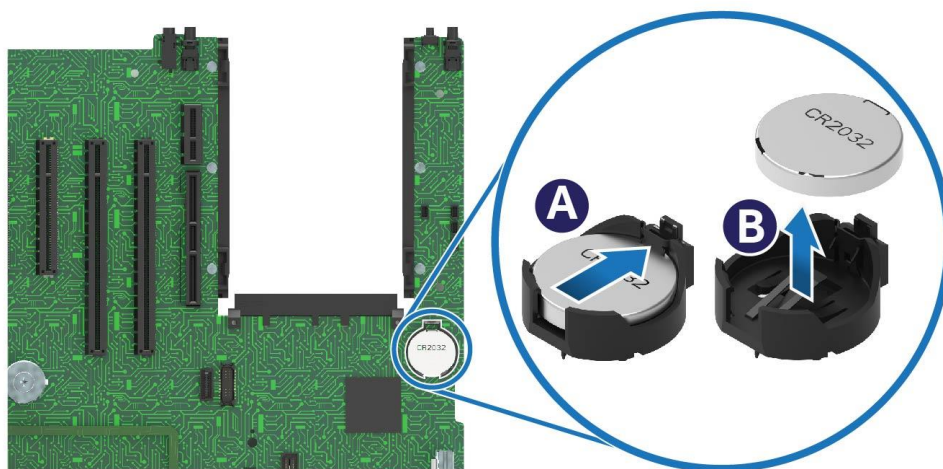
### Required Tools and Supplies

- Anti-static wrist strap and conductive workbench pad (recommended)
- CR-2032 Replacement Battery

**Average Time to Complete:** ~ 5 minutes

### Procedure Prerequisites

- The system must be powered off and AC power cord(s) disconnected.
- Remove the system top cover and air duct ( See [Sections 2.2.1](#) and [2.2.2](#)).
- (If present) Remove the riser card #0 assembly from the system (see [Section 3.2.3](#)).

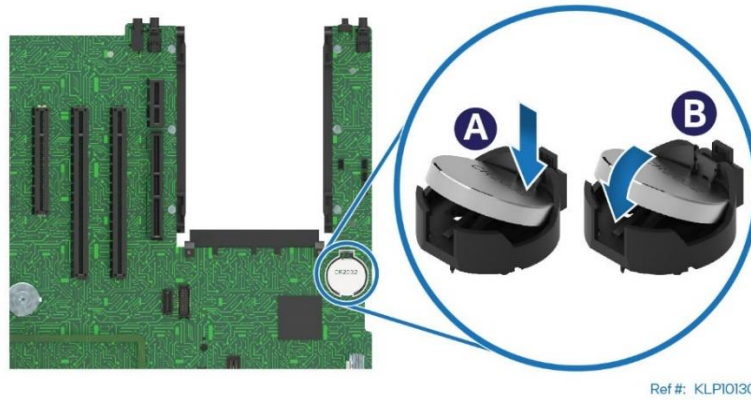


Ref #: KLPI0090

**Figure 79. System Battery Removal**

1. Locate the battery on the server board.
2. Press the metal clip to release the battery (see Letter A).
3. Remove the battery from its socket (see Letter B).
4. Dispose of the battery according to local laws.

5. Unpack the new battery



**Figure 80. System Battery Installation**

6. Orient the battery so that its positive (+) side is facing up.
7. Carefully insert the new battery into the battery socket. Ensure it is locked in place.

---

**Note:** After the system is reassembled and AC power is applied to the system, it will be necessary to access the <F2> BIOS Setup utility at first power-on to reset the system time and date, and reset BIOS options to their original settings.

---

## 5.4 Power Supply Module Replacement

### Required Tools and Supplies

- Anti-static wrist strap and other anti-ESD precautions followed (recommended)
- Replacement 2000W power supply module

**Average Time to Complete:** < 3 minutes

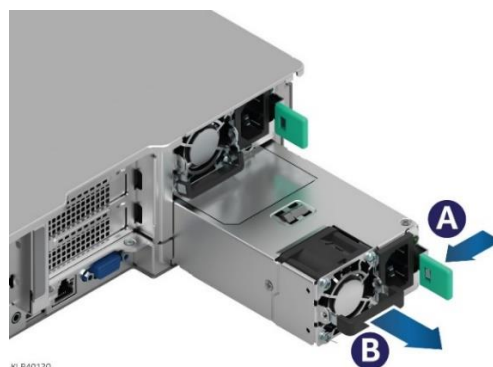
### Procedure Prerequisites

- It is recommended that the system be powered down and unplugged from the AC power source before replacing a faulty power supply module. However, power supply modules are hot-swappable\*\*. If necessary, the following procedure can be performed while the system is still operational.

---

**\*\* Note:** A power supply module is only hot-swappable (replaced without first powering down the system) if the system is configured with two power supply modules and remains operational (powered on) after platform management reports that a power supply failure has occurred and power redundancy is lost.

---



**Figure 81. Power Supply Module Extraction**

1. Identify the power supply module to be replaced (see the LED on the back of the power supply).
2. Disconnect the AC power cord of the faulty power supply from the AC power source.
3. Disconnect the AC power cord from the faulty power supply module.
4. While pushing in the green latch (see Letter A), use the handle to pull the power supply module from the system (see Letter B).
5. Locate and unpack the replacement power supply.



**Figure 82. Power Supply Module Installation**

6. Insert the power supply module into the empty bay and push it in until the green latch locks the module in place.
7. Install the AC power cord to the power supply module.
8. Connect the AC power cord to the AC power source.

## 5.5 Front 2.5" Drive Replacement

The system may have support for 8, 16, or 24 front drive bays. Each drive bay will include a drive carrier that must be populated with a drive (SSD or HDD) or supplied drive blank. All drives attached to a common backplane must match media type (SSD or HDD). Mixing drive storage media types within a common backplane is not supported. In addition, all drives attached to a common backplane must share a common interface type (SATA/SAS or NVMe).

---

**Note:** To support proper airflow requirements within the system, all drive carriers installed within the front drive bay must be populated with a drive or supplied drive blank insert.

---

Drive carrier removal from the chassis and installation into the chassis is tool-less. However, installing a drive into the drive carrier requires a Phillips\* head screwdriver.

### Required Tools and Supplies

- Anti-static wrist strap and ESD safe workbench (recommended)
- Phillips head screwdriver

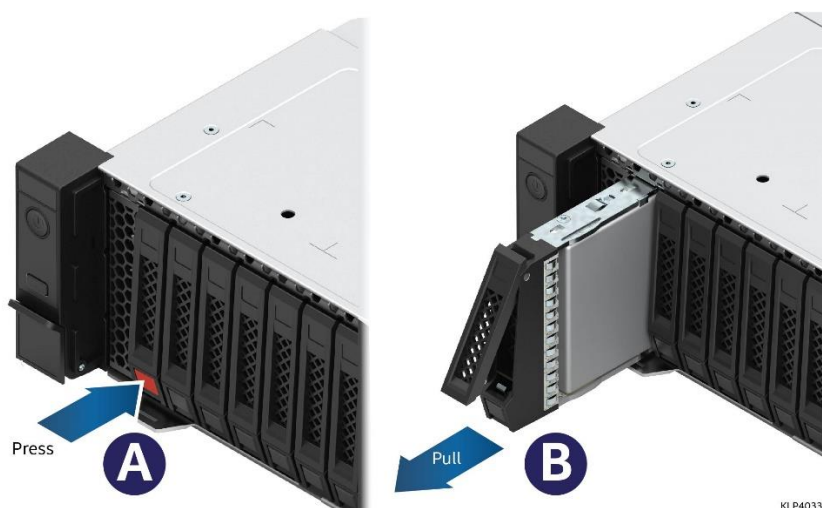
**Average Time to Complete:** ~ 5 minutes

### Procedure Prerequisites

- It is recommended that the system be powered down and unplugged from the AC power source before replacing a faulty drive (SSD or HDD) from the front drive bay. However, the backplane within the drive bay does support swapping out faulty drives while the system is operational. Hot swapping a drive should only be performed if the faulty drive was configured as part of a fault tolerant RAID configuration (RAID 1, 5, 6, 10, 50, or 60).
- Identify and locate the faulty drive using management software and / or the drive fault LED.

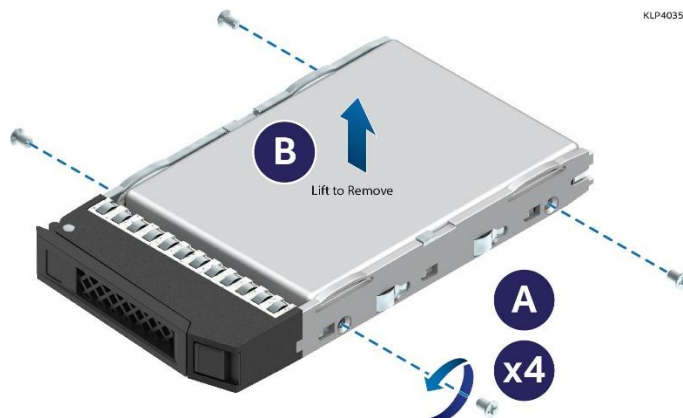


## 5.5.1 Drive Removal



**Figure 83. Front Drive Bay - Drive Extraction**

1. Remove the drive carrier from the system.
  - Push the button to release the drive carrier latch (see Letter A).
  - Using the latch, pull the drive carrier from the drive bay (see Letter B).

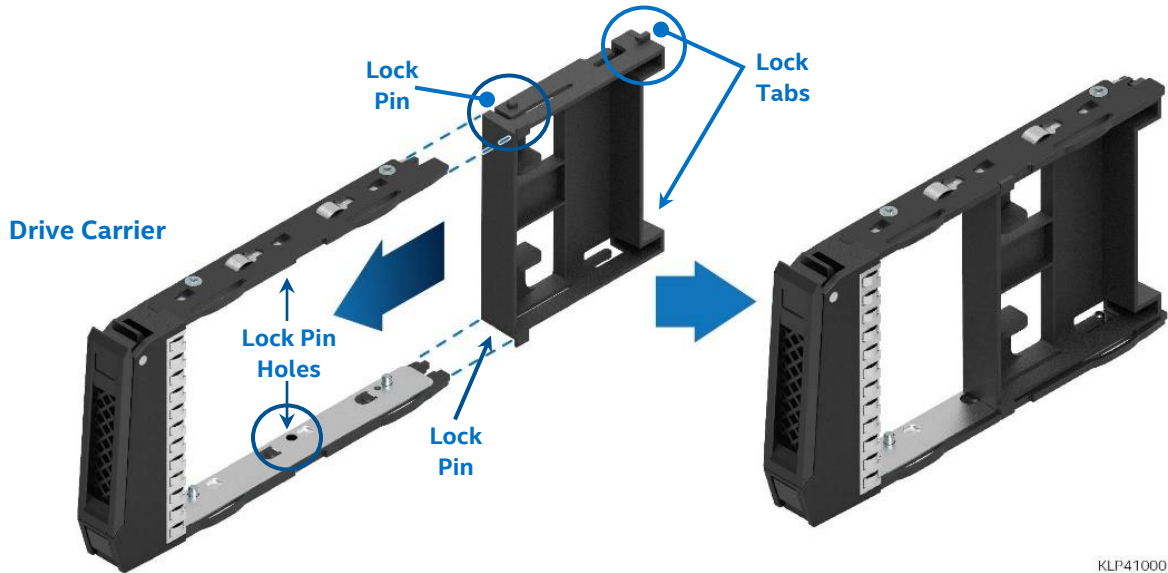


**Figure 84. 2.5" Drive Removal from Drive Carrier**

2. Remove the drive from the drive carrier.
  - Using a Phillips head screwdriver, remove the four screws holding the drive to the drive carrier (see Letter A).
  - Remove the drive from the drive carrier (see Letter B).

If the drive is not being replaced with another, then a drive blank insert must be installed to the drive carrier before reinstallation into the drive bay.

The drive blank insert includes lock pins and lock tabs as alignment and locking features to ensure secure placement within the drive carrier.



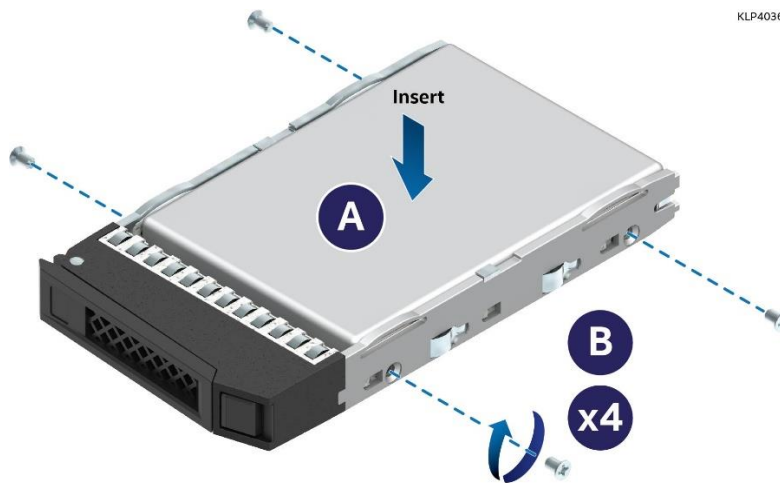
KLP41000

**Figure 85. Drive Blank Installation to Drive Carrier**

- Locate the drive blank insert.
- Position the drive blank insert behind the drive carrier.
- Carefully slide the drive blank insert between the two drive carrier slide rails.
- The drive blank insert is correctly installed when the two lock pins are seated within the lock pin holes on the inside of the drive carrier rails, and the two lock tabs are seated within the slots on the back edge of the drive carrier rails.

### 5.5.2 Drive Replacement

1. Locate and unpack the new drive.



KLP40360

**Figure 86. 2.5" SSD Installation to Drive Carrier**

2. Carefully position the drive between the drive carrier slide rails (see Letter A).
3. Ensure all mounting holes on the rails align with those of the drive.
4. Using four (4) screws, fasten the drive to the drive carrier rails (see Letter B).



**Figure 87. Drive Assembly Installation to Front Drive Bay**

5. Ensure the drive carrier latch is in the outward open position.
6. Carefully push the drive assembly into the drive bay until fully inserted.
7. Close the drive carrier latch to secure the drive to the drive bay.

## 5.6 Intel® VROC 7.5 Key Replacement

This section provides instructions to replace an Intel® VROC for NVMe Key.

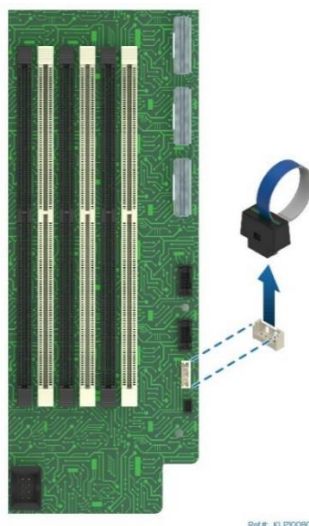
### Required Tools and Supplies

- Anti-static wrist strap and ESD safe workbench (recommended)
- Replacement Intel® VROC 7.5 key

### System Prerequisites

- The system must be powered off and AC power cord(s) disconnected

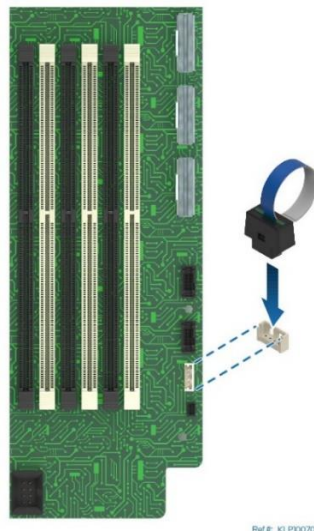
#### 5.6.1 Intel® VROC 7.5 (VMD NVMe\* RAID) Key Removal



**Figure 88. Intel® VROC Key Removal**

1. Locate the Intel® VROC for NVMe Key near the bottom right edge of the server board.
2. Using the key pull tab, carefully pull up on the key until it disengages from the connector.

## 5.6.2 Intel® VROC 7.5 (VMD NVMe\* RAID) Key Installation



**Figure 89. Intel® VROC Key Installation**

1. Remove the Intel® VROC for NVMe key from its packaging.
2. Ensure the key and server board connector are oriented correctly.
3. Press the key down onto the connector until it locks into place.

## 5.7 Backplane Replacement

The following provides instructions for the replacement of a faulty backplane.

### Required Tools and Supplies

- No tools are required to replace a faulty backplane
- Follow all ESD precautions described in the Safety section at the beginning of this document
- Replacement backplane

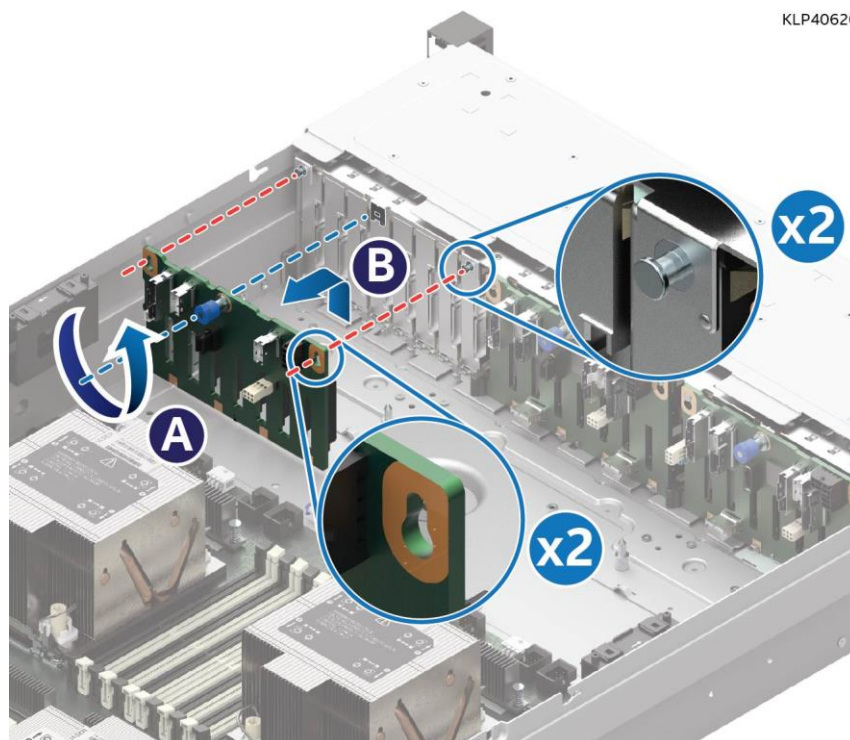
**Average Time to Complete:** < 10 minutes

### Procedure Prerequisites

- The system must be powered off and AC power cord(s) disconnected.
- Place the system on an ESD safe non-skid work bench.
- Remove the system top cover and air duct (see [Sections 2.1.1](#) and [2.1.2](#)).
- Remove the system fan housing (see [Section 2.3.2](#)).

### 5.7.1 Backplane Removal

1. From the front drive bay, remove all drives attached to the faulty backplane.
2. Carefully disconnect all cables from the back side of the faulty backplane
  - All cable connectors have latches that must be released to disconnect the cable from the backplane. DO NOT pull directly on the cables without first unlatching them.



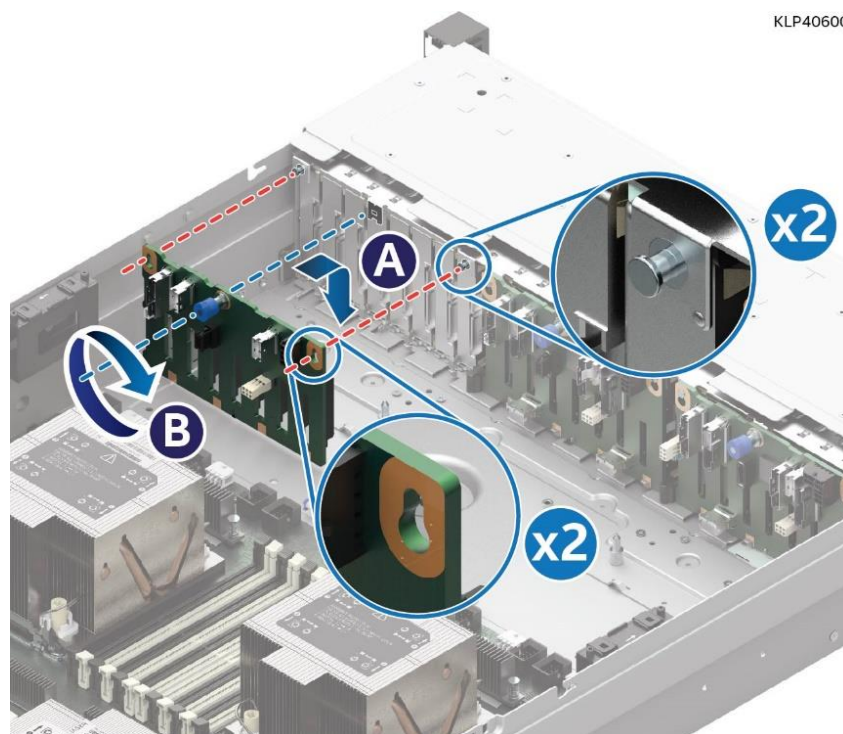
**Figure 90. Backplane Removal**

3. On the backplane, turn the blue thumbscrew counterclockwise  $\frac{1}{4}$  turn, unlocking the backplane from the drive bay (see Letter A).
4. Carefully lift and pull the backplane away from the drive bay (see Letter B).



## 5.7.2 Backplane Installation

1. Locate and unpack the replacement backplane.



**Figure 91. Backplane Installation**

2. Carefully align and place the two mounting keyholes of the backplane over the mounting studs on the drive bay (see Letter A).
3. Ensure no cables are laying beneath the backplane. Then, gently push down on the backplane until securely seated.
4. Push in and turn the blue thumbscrew clockwise to secure the backplane to the drive bay (see Letter B).
5. Ensure proper orientation and re-attach all cables to the backplane.
6. Reinstall all drives to the front drive bay (see [Section 5.5](#)).
7. Reinstall the system fan housing (see [Section 2.3.2.2](#)).
8. Reinstall system air duct (see [Section 2.2.1](#)).
9. Reinstall system top cover (see [Section 2.2.2](#)).

## 5.8 Power Distribution Board (PDB) Replacement

The following provides instructions for the replacement of a faulty power distribution board (PDB).

### Required Tools and Supplies

- Anti-static wrist strap, an ESD safe workbench, and other anti-ESD precautions (recommended)
- No tools are required to replace a faulty PDB
- Replacement Power Distribution Board

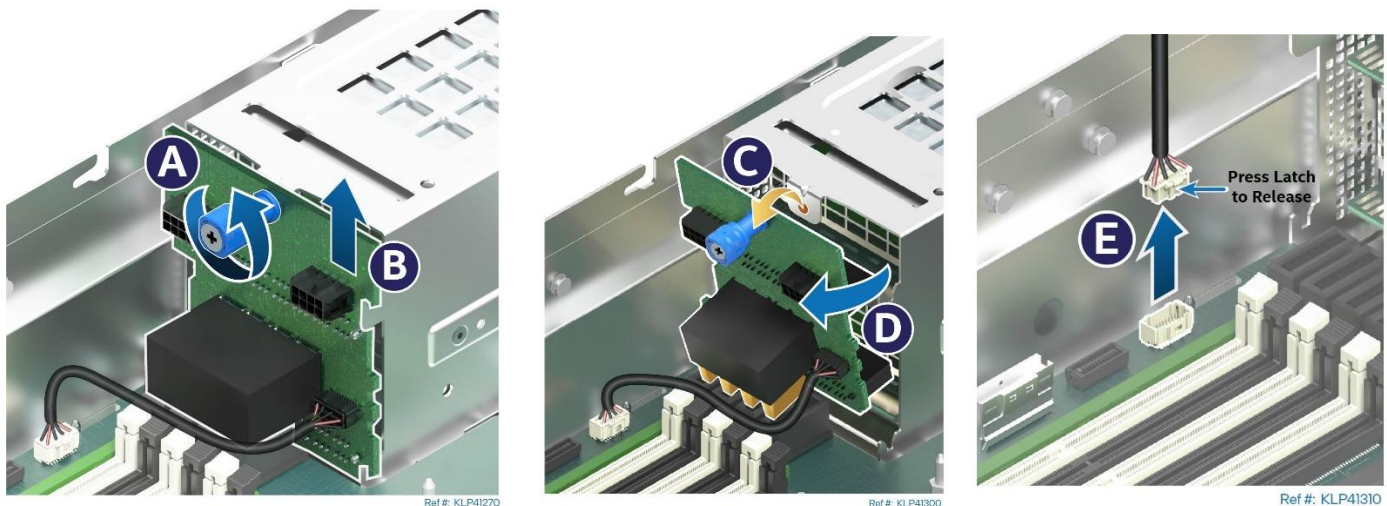
**Average Time to Complete:** < 10 minutes

### Procedure Prerequisites

- The system must be powered off and AC Power cord(s) disconnected.
- Remove the system top cover and air duct (see [Sections 2.1.1](#) and [2.1.2](#)).
- Place the system on an ESD safe non-skid work bench.

### 5.8.1 Power Distribution Board (PDB) Removal

1. Remove the power supply modules from the back of the system (see [Section 5.4](#)).

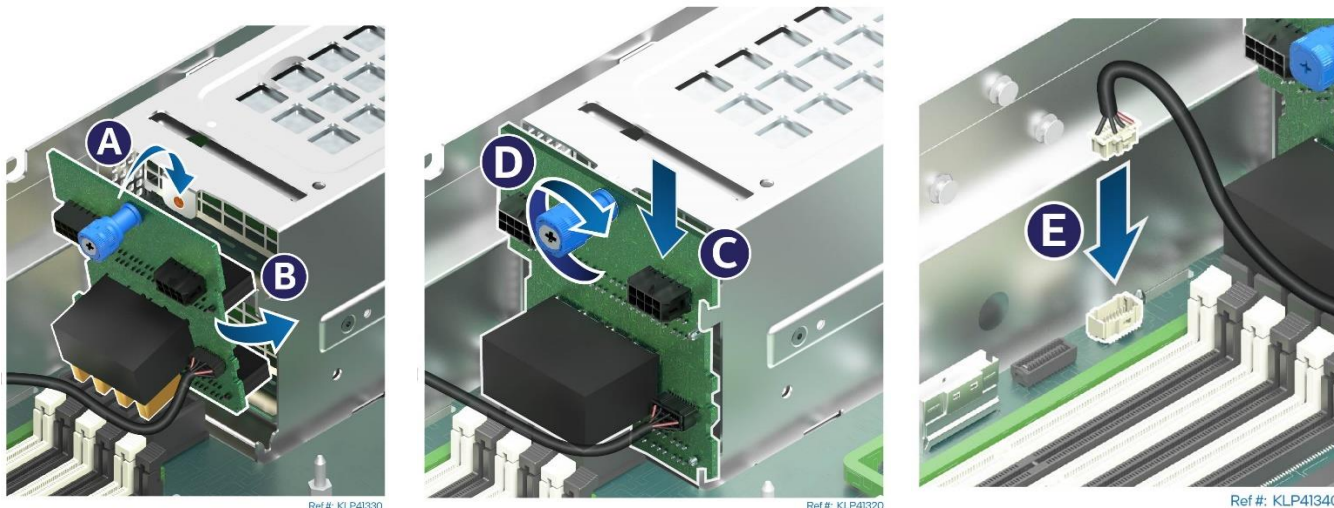


**Figure 92. Power Distribution Board Removal**

2. Fully loosen the blue thumbscrew. The thumbscrew is captive and cannot be removed (see Letter A).
3. Using the thumbscrew shaft carefully pull-up on the PDB until it disengages from the server board (see Letter B).
4. Tilt the top edge of the PDB forward (see Letter C). Then, carefully pull the PDB out and away from the power supply bay (see Letter D).
5. Carefully grasp the PDB cable connector. While pushing in the top edge of the latch, pull the cable from the server board (see Letter E).

## 5.8.2 Power Distribution Board (PDB) Installation

1. Locate and unpack the new replacement PDB.



**Figure 93. Power Distribution Board Installation**

2. Carefully position the PDB to the front side of power supply bay and align it over the main power connector slots on the server board (see Letters A and B).
3. Push down on the PDB until fully seated within the slots on the server board (see Letter C)
4. Tighten the blue thumbscrew to secure the PDB to the power supply bay (see Letter D).
5. Align and insert the PDB cable to the matching connector on the server board (see Letter E).
6. Reinstall the system air duct and top cover (see [Section 2.2](#)).

## 5.9 Processor Replacement

Processors in this system are part of an assembly referred to as a PHM (Processor Heat sink Module). A PHM consists of a processor, a processor carrier clip, and the processor heat sink, which is preassembled into a single module before placement onto the processor socket assembly on the server board. The PHM concept reduces the risk of damaging pins within the processor socket during the replacement process.

### Components Required:

- New matching 3<sup>rd</sup> Gen Intel® Xeon® processor Scalable processor + included shipping tray
- Existing processor carrier clip
- New processor heat sink or existing processor heat sink + new thermal interface material (TIM)

### Required Tools and Supplies

- Anti-static wrist strap, an ESD safe workbench, and other anti-ESD precautions (recommended)
- ESD Gloves (recommended)
- T-30 Torx\* screwdriver

**Average Time to Complete:** ~10+ minutes

### Procedure Prerequisites

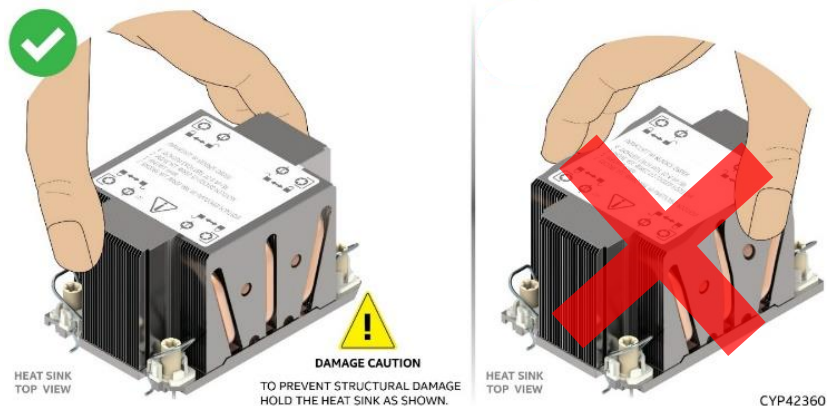
- The system must be powered off and AC Power cord(s) disconnected.
- Remove the system top cover and air duct (see [Sections 2.1.1](#) and [2.1.2](#)).

---

**Caution:** Fin edges of the processor heat sink are very sharp. Intel recommends wearing thin ESD protective gloves when handling the PHM during the following procedures.

---

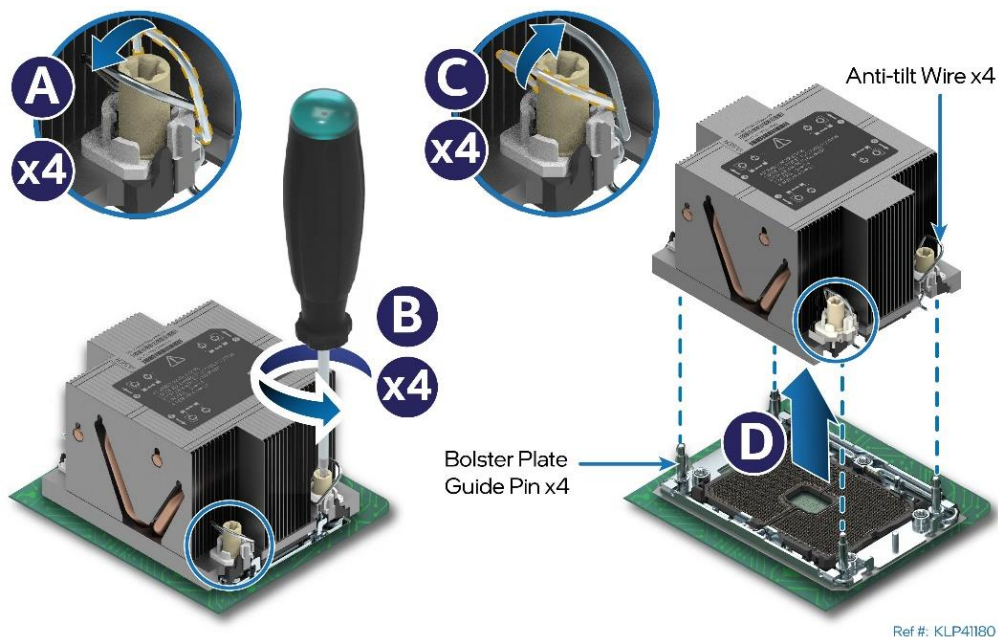
**Caution:** Processor heat sinks are easily damaged if handled improperly. See the following image for proper handling.



**Figure 94. Processor Heat Sink Handling**

### 5.9.1 Processor Heat Sink Module (PHM) Removal

1. Identify and locate the faulty processor.



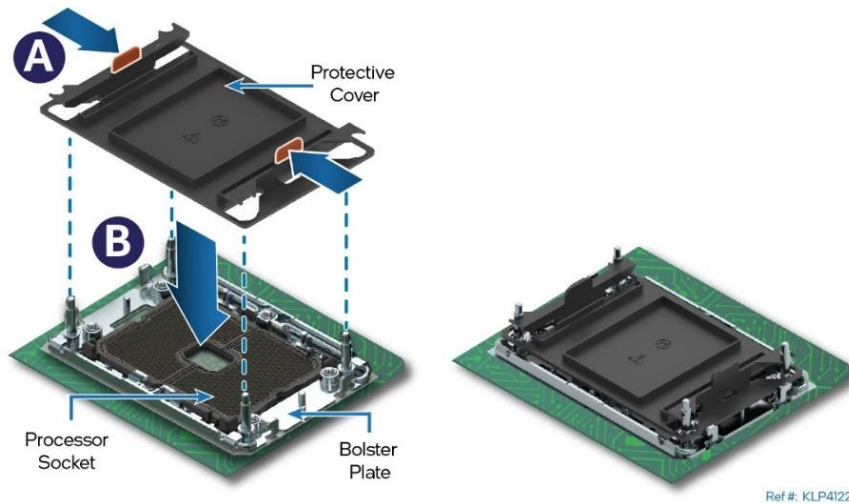
**Figure 95. PHM Assembly Removal from Processor Socket**

2. Ensure the heat sink anti-tilt wire located over each of the four heat sink fasteners are in the outward position (see Letter A).
3. Fully loosen all four heat sink fasteners in the following order – 4, 3, 2, 1 (see Letter B).
  - Reference the label atop of the heat sink for fastener numbering
4. Set all four anti-tilt wires on the heat sink to the inward position (see Letter C).
5. Carefully grasp the PHM and lift it straight up and off the server board (see Letter D).
6. With the processor facing up, set the PHM down onto a flat surface.
7. Visually inspect that the processor socket is free of damage or contamination.

**Note:** If debris is observed, blow it away gently. Do not use tweezers or any other hard tools to remove the debris.



If not replacing the processor, install the original plastic socket cover over the processor socket.



**Figure 96. Processor Socket Cover Installation**

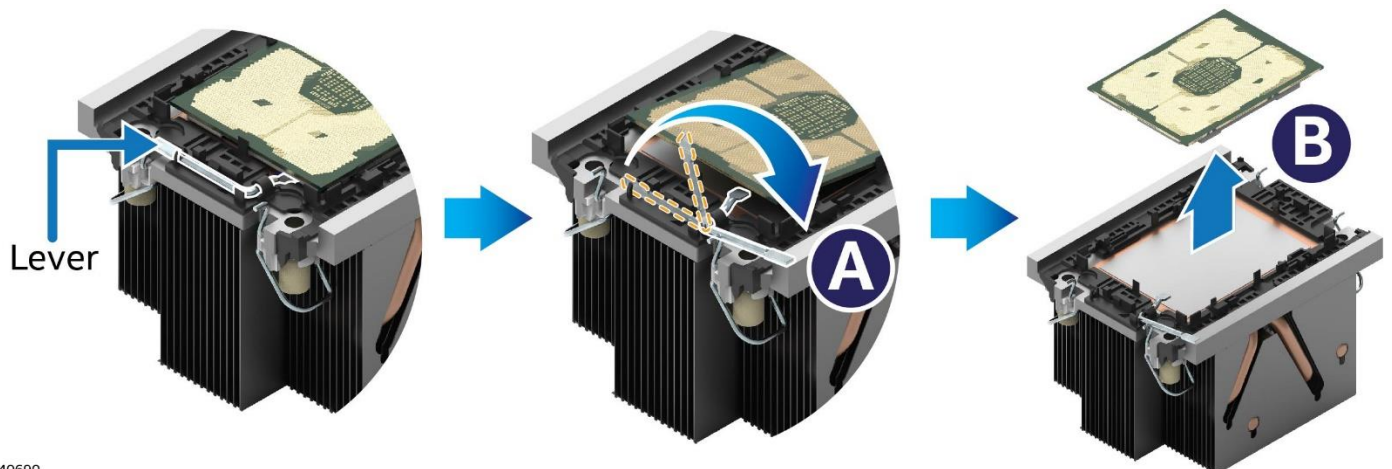
- Squeeze the finger grips at each end of the cover (see Letter A).
- Carefully lower the cover over the four alignment pins of the bolster plate and onto the processor socket (see Letter B).
- Release the finger grips to lock the cover in place.
- Ensure socket cover is locked in place.

---

**Caution:** Do not press down on the center of the socket cover.

---

## 5.9.2 PHM Disassembly

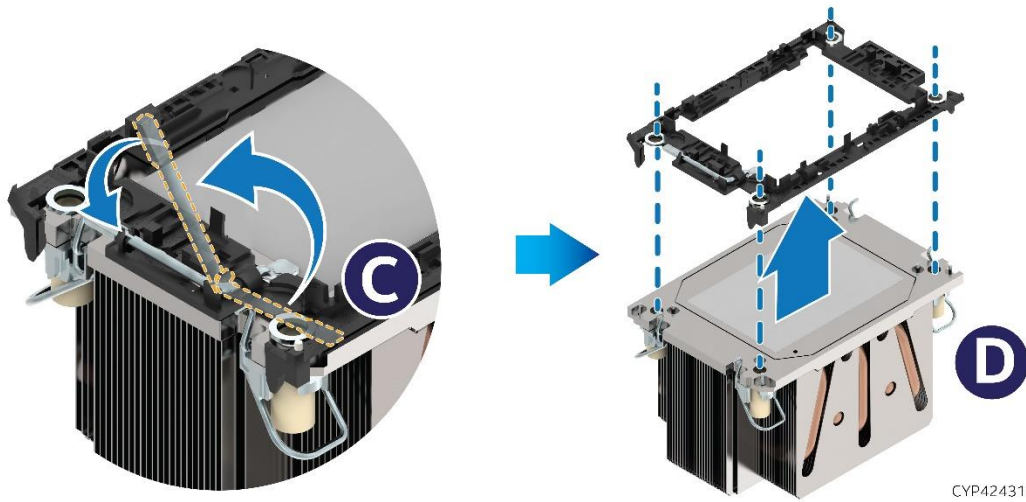


KLP40690

**Figure 97. Processor Removal from PHM Assembly**

1. While holding down the PHM, rotate the lever (see Letter A) from left to right until the processor lifts free from the processor carrier clip.
2. Holding down the processor carrier clip, carefully lift out the processor (see Letter B).





**Figure 98. Processor Carrier Clip Removal from PHM Assembly**

3. Return the lever to the original position (see Letter C).
4. Detach the processor carrier clip from the heat sink.
  - Unlatch the hook on each corner of the processor carrier clip and lift it from the heat sink (see Letter D).

### 5.9.3 PHM Reassembly

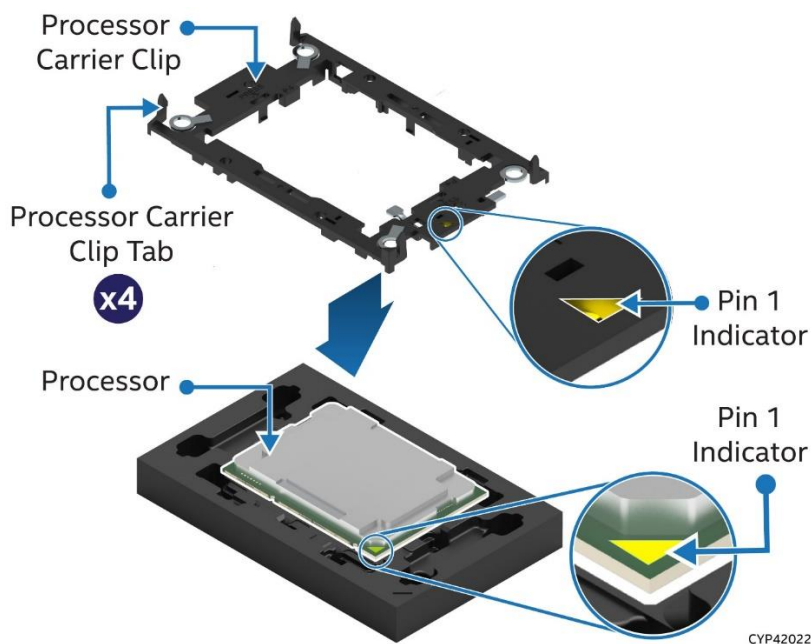
To properly assemble the PHM and install it onto the server board, the procedures described in the following sections must be followed in the order specified. These instructions assume that the processor heat sink (New or reuse of existing) has the necessary Thermal Interface Material (TIM) (DOWSIL™ TC-5888) already applied.

---

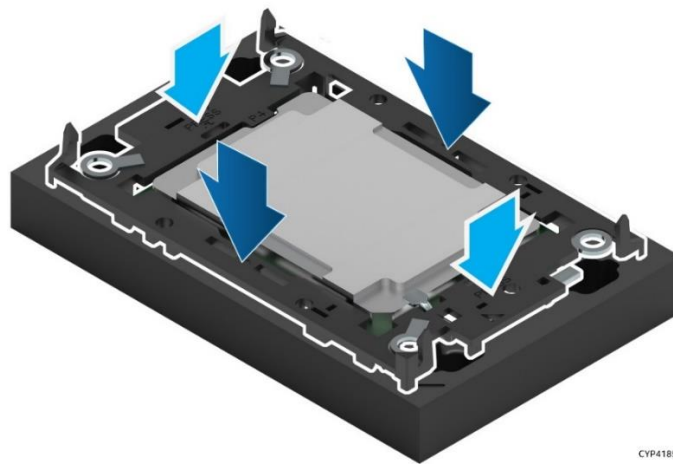
**Note:** Full ESD precautions should be followed to perform reassembly of the PHM and reinstallation of the PHM to the server board. At no time should the processor itself be handled.

---

Each component within the PHM assembly includes a Pin 1 indicator. Pin 1 indicator alignment between all components is required throughout the assembly process.

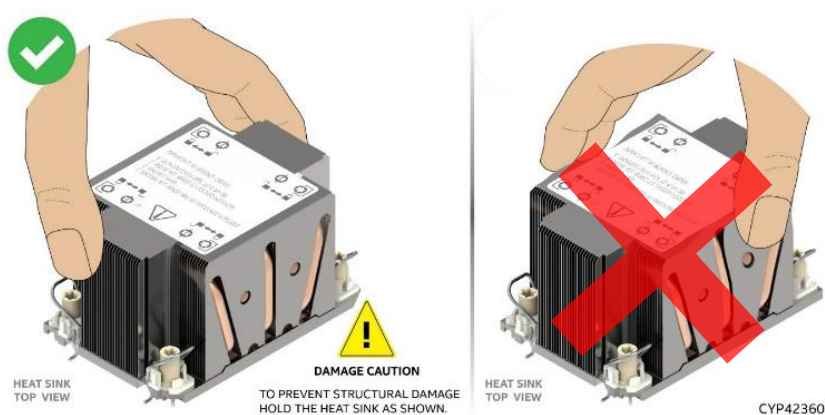


**Figure 99. Installing Processor Carrier Clip onto Processor – Part 1**



**Figure 100. Installing Processor Carrier Clip onto Processor – Part 2**

1. With the processor still in its tray, place the processor carrier clip over the processor.
2. Ensure the pin 1 indicator on the processor carrier clip is aligned with the pin 1 indicator of the processor.
3. Gently press down simultaneously on two opposite sides of the processor carrier clip until it clicks in place.
4. Repeat step 3 for the other two sides.
5. Locate the processor heat sink. To avoid damage, grasp it by its narrower sides as shown in [Figure 101](#).



**Figure 101. Processor Heat Sink Handling**

6. Place the heat sink bottom side up onto a flat surface.

If reusing an existing heat sink

- Properly clean off existing thermal interface material (TIM) from the bottom of the heat sink
- Apply new TIM (DOWSIL™ TC-5888)

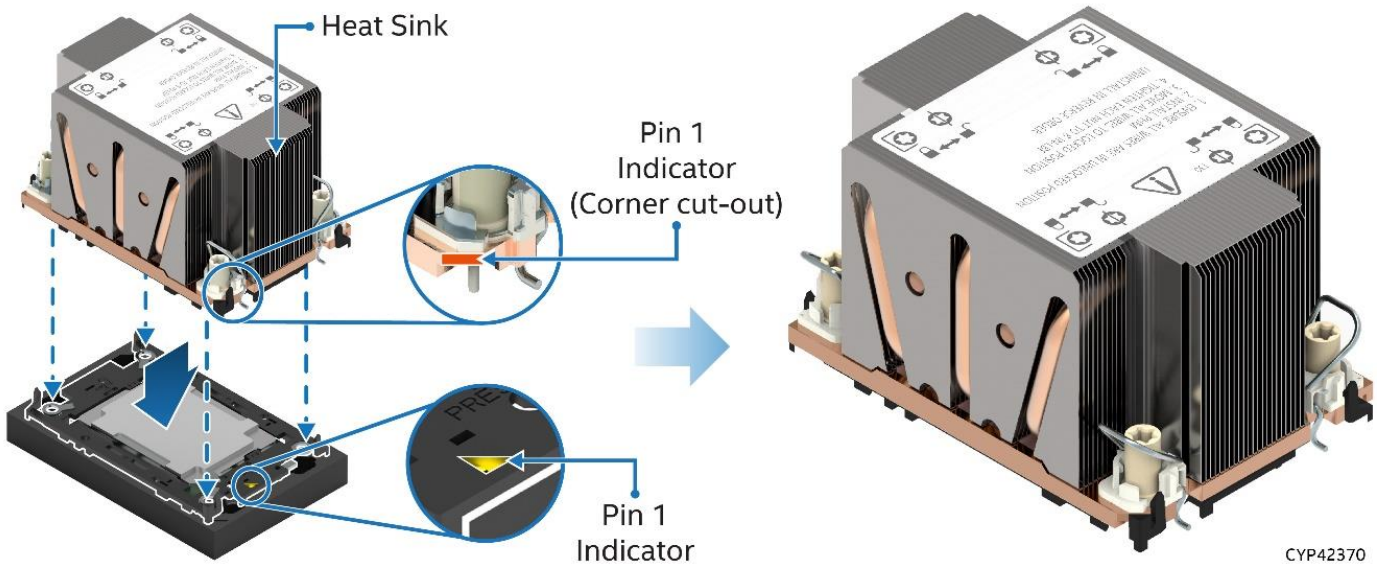
If using a new heat sink

- Remove the plastic protective film (if present) from the Thermal Interface Material (TIM).



**Figure 102. Processor Heat Sink Anti-tilt Wires in the Outward Position**

7. Set the anti-tilt wire over each of the four heat sink fasteners to their outward position.



**Figure 103. Pin 1 Indicator of Processor Carrier Clip**

8. Align the pin 1 indicator of processor carrier clip with one of the diagonally cut corners on the base of the heat sink. Or (If present) look for the Pin #1 indicator on the corner of the heat sink label.
9. Gently press down the heat sink onto the processor carrier clip until it clicks into place.
10. Ensure all four heat sink corners are securely latched to the carrier clip tabs.

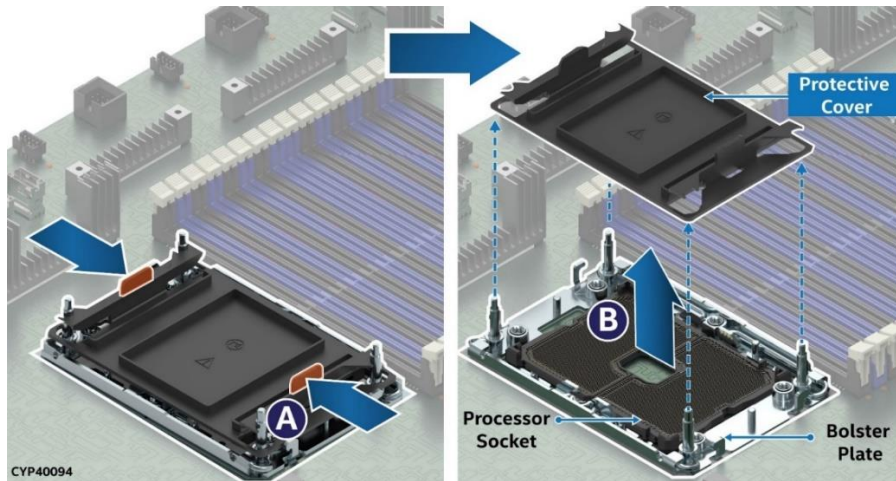
### 5.9.4 PHM Installation

If installed, remove the plastic cover from the processor socket

---

**Caution:** Do not touch the socket pins. The pins inside the processor socket are extremely sensitive. A damaged processor socket may produce unpredictable system errors.

---



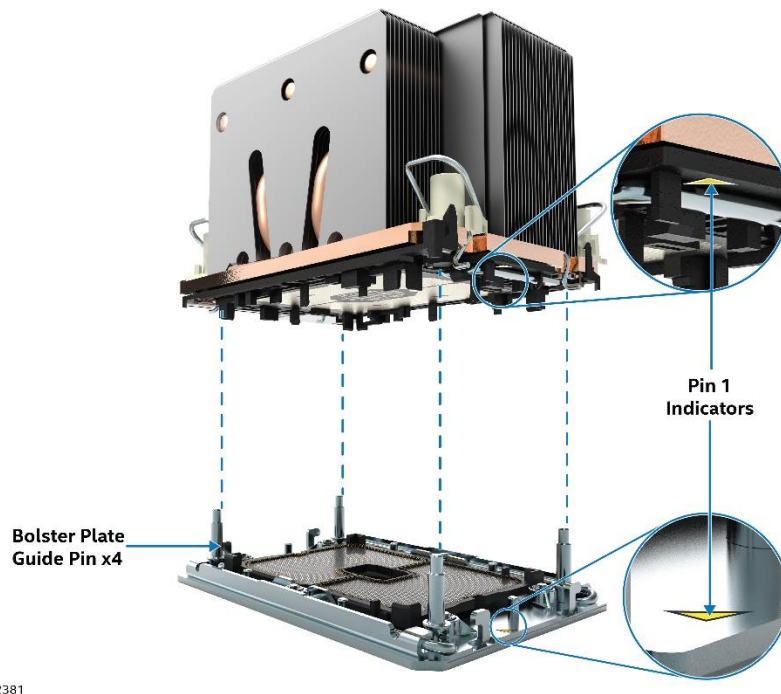
**Figure 104. Processor Socket Cover Removal**

- Remove the protective cover by squeezing the finger grips (see Letter A) and pulling the cover up (see Letter B).
- Ensure the socket is free of damage or contamination before installing the PHM.

---

**Caution:** If debris is observed, blow it away gently. Do not remove it manually, such as with tweezers.

---



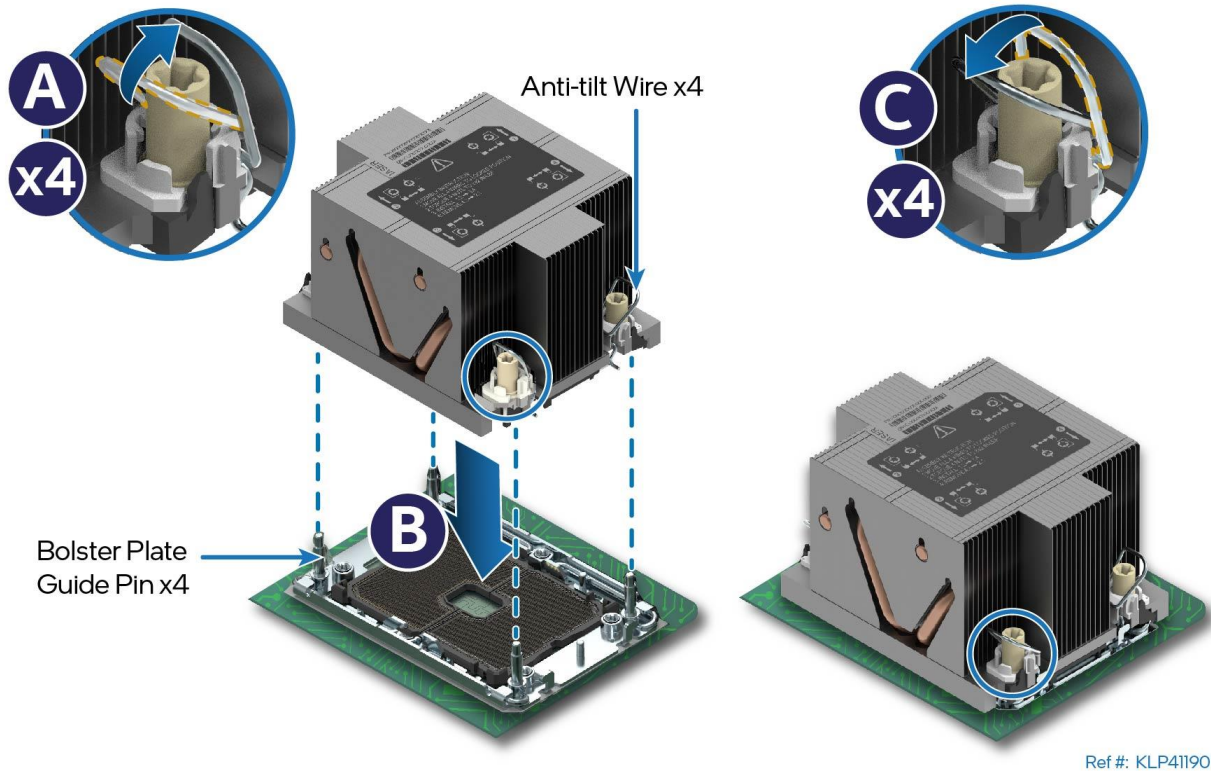
**Figure 105. PHM Alignment with Processor Socket Assembly**

---

**Caution:** Processor socket pins are delicate and bend easily. Use extreme care when placing the PHM onto the processor socket. Do not drop it.

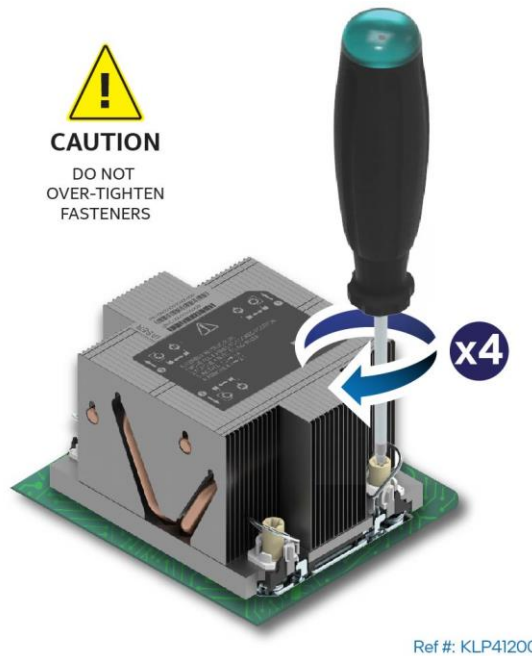
---





**Figure 106. PHM Installation onto Server Board**

1. Set all four anti-tilt wires on the heat sink to the inward position (see Letter A).
2. Align the pin 1 indicators of the processor carrier clip and processor with the pin 1 indicator on the socket assembly bolster plate.
3. Carefully lower the PHM over the four bolster plate alignment pins (see Letter B).
4. Ensure the PHM is sitting flat and even on the bolster plate.
5. Set all four anti-tilt wires on the heat sink to the outward position (see Letter C).



**Figure 107. Tighten Heat Sink Fasteners**

6. Using a T30 Torx\* screwdriver, tighten (in order 1,2,3,4) the heat sink fasteners to 8 in-lb.
7. Reinstall the air duct and system cover (see [Sections 2.2.1](#) and [2.2.2](#)).



## 5.10 Server Board Replacement

Replacing the server board within the Intel® Server System M70KLP is considered a major service procedure. This procedure should only be performed by qualified service technicians.

### Before You Begin

Before performing this procedure, review all the safety and ESD precautions found in the Safety Warnings section at the beginning of this document.

---

**Note:** All components removed from the system must be kept on an ESD safe work surface or into an ESD safe bin or bag while full system disassembly and reassembly is in progress.

---

### Required Tools and Supplies

- Anti-static wrist strap and conductive workbench pad (recommended)
- ESD protective gloves (recommended)
- Phillips\* (cross head) screwdriver #1
- T-30 Torx\* screwdriver
- Small Pliers
- Replacement server board

**Average Time to Complete:** ~ 45 minutes

### Procedure Prerequisites

- The system must be powered off and AC power cord(s) disconnected
- Label and Disconnect all cables attached to the back of the system
- Place the system on an ESD safe non-skid work bench

#### 5.10.1 Server Disassembly

1. Remove power supply modules from the back of the system (see [Section 5.3](#)).
2. (If Present) Remove the OCP add-in card from the back of the system (see [Section 3.5.2](#)).
3. Remove the system top cover and air duct (see [Section 2.1](#)).
4. Remove the system fans, fan housing, and both mounting brackets (see [Section 2.3.2.1](#)).
5. (If present) Remove all riser card assemblies from the system (see [Section 3.2.4](#)).
  - Label and Disconnect all internal cables attached to the riser card assembly.
  - Add-in cards do not have to be removed from the riser assembly.
6. (If present) Remove all add-in cards from the PCIe slots on the server board (see [Section 3.2.2](#)).
  - Label and Disconnect all internal cables attached to the PCIe add-in cards.
7. Remove all memory modules and DIMM blanks from the server board (see [Section 5.2](#)).
  - Note the memory slot locations for all DDR4 DIMMs being removed.
  - **Note:** If the system configuration includes Intel® Optane™ PMem devices, note the location of each device being removed for re-installation into the new system. Additionally, to protect data that may be stored on them, Intel® Optane™ PMem devices are password protected. Reinstallation of existing PMem devices into the new system will require their original configured password to re-enable their use.
8. Remove all processor heat sink modules (PHM) from the server board (see [Section 5.9.1](#)).
  - Install processor socket covers over each processor socket.
  - PHM disassembly is not required.
9. (If Present) Remove the Trusted Platform Module (TPM) mounted on the server board.
10. (If present) Remove the Intel® VROC option key mounted on the server board (see [Section 5.6.1](#)).

11. Remove the Power Distribution Board (PDB) mounted to the front of the power supply bay (see [Section 5.8.1](#)).
12. Label and disconnect all remaining cables attached to the server board.

---

**Note:** All cable connectors have latches to secure them to the connectors on the board. DO NOT attempt to pull off a cable without unlatching them.

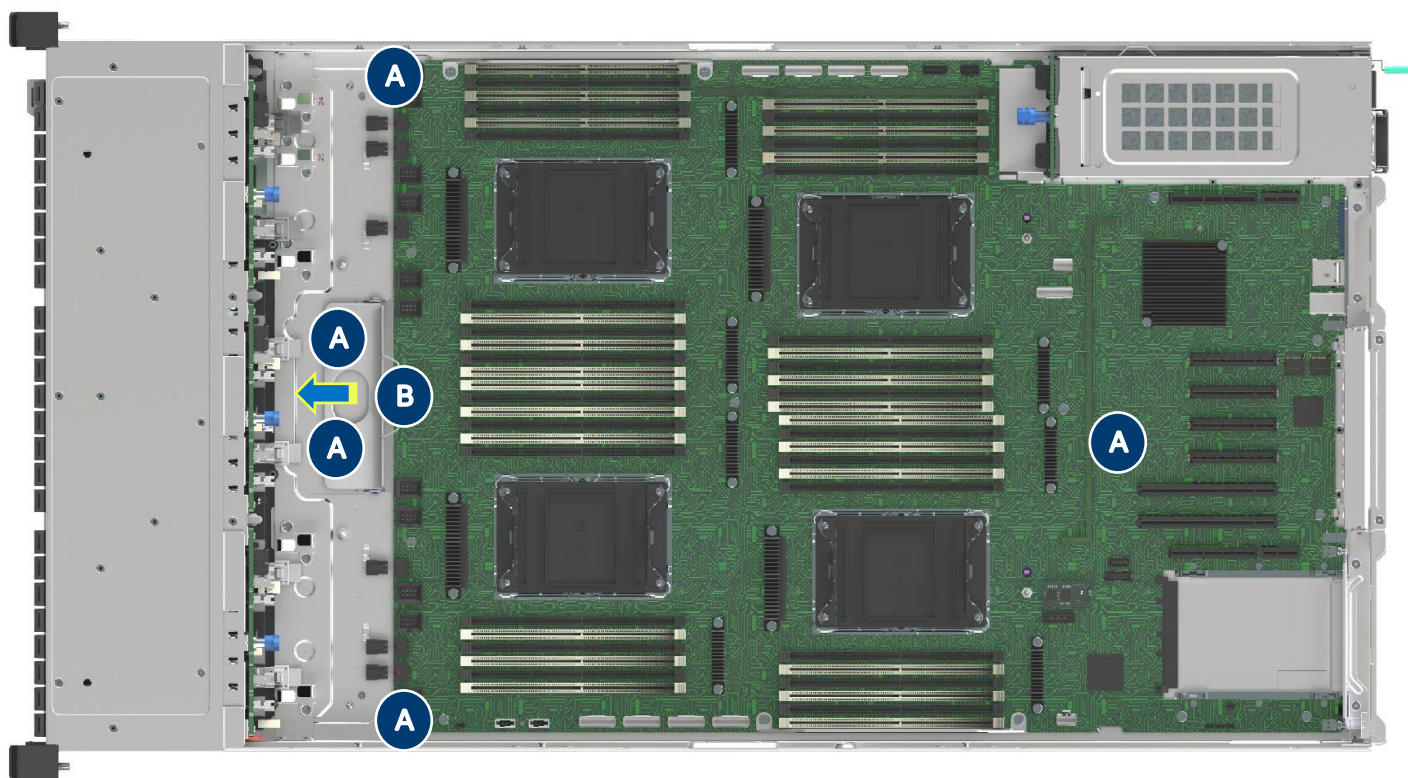
---

13. Remove the four cable management brackets from the chassis sidewalls.
  - Cable management brackets slide off mounting studs on the chassis sidewall.

## 5.10.2 Server Board Removal

This section is a continuation from [Section 5.10.1](#).

Ensure the system is laying on a non-skid surface. The server board is secured to a mounting plate held in place by keyed stand-offs on the chassis base and 5 blue thumbscrews. After loosening the thumbscrews, the server board is pulled forward towards the front drive bay.



Ref #: KLP20200

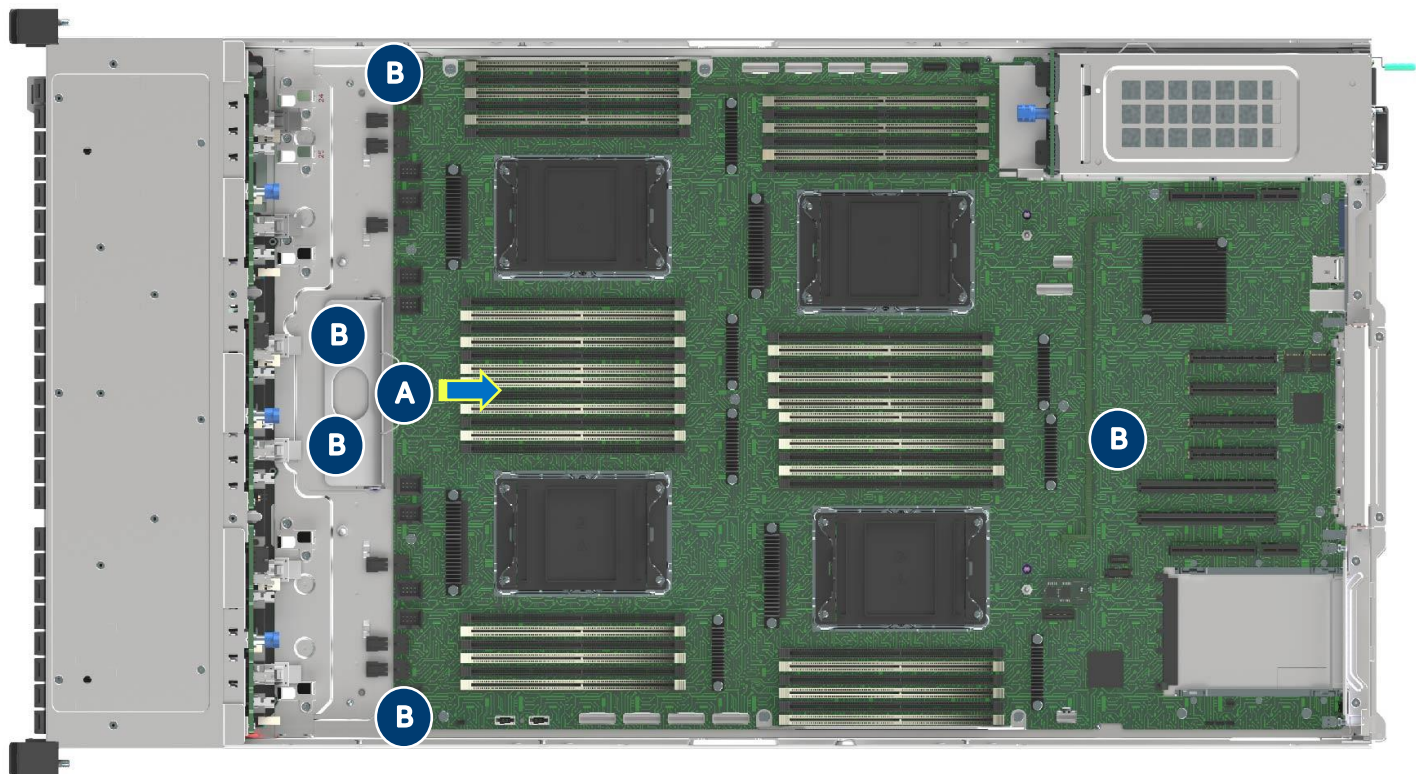
**Figure 108. Server Board Removal**

1. Locate and fully loosen the five (5) blue thumbscrews (see Letters A). Thumbscrews are captive and are not removable.
2. While standing in front of the system, with one hand hold the front of the chassis to prevent the system from sliding. With the other hand grasp the mounting plate handle in front of the leading edge of the server board (see Letter B).
3. Pull the server board towards the front drive bay approximately 11 mm (1/2").
4. Carefully grip the front and back edges of the server board and lift it out of the chassis.
5. Place the server board onto an ESD safe surface or into an ESD safe bin or bag.

### 5.10.3 Server Board Installation

This section is a continuation from [Section 5.10.2](#).

1. Locate and unpack the replacement server board.
  - The replacement server board is pre-assembled to the mounting plate
  - Take care to only handle the server board by its edges.
2. Orient and carefully lower the server board into the chassis.



Ref #: KLP20200

**Figure 109. Server Board Installation**

3. Standing behind the system, grasp the mounting plate handle (see Letter A) and pull the server board towards the back of the system.
  - **Note:** While pulling back the server board with one hand, it may be necessary to apply slight downward pressure on the server board (just in front of the PCIe add-in slots) with the other hand to ensure all the key slots of the mounting plate slide over the mounting studs of the chassis.
  - The server board is in place when all connectors and buttons on the back edge of the server board protrude from the chassis back panel.
4. Starting with the blue thumbscrew closest to the back of the system, tighten the five (5) blue thumbscrews to secure the mounting plate to the chassis (see Letters B).
  - **Note:** The rear thumbscrew should easily tighten using little force. If the thumbscrew does not tighten easily, DO NOT force it. Slide the server board towards the front drive bay and redo Step 3 until the mounting plate is properly seated over all the chassis base studs and the server board is properly aligned with the back panel.



## 5.10.4 System Reassembly

This section is a continuation from [Section 5.10.3](#).

1. Install the power distribution board (see [Section 5.8.2](#)).
2. Attach the following cables to the server board in the order specified.
  - **Note:** check connector alignment and orientation before attaching cable to the server board.
  - All backplane power cables – multi-color wires – connect to left front edge of the server board.
  - All backplane I<sup>2</sup>C cables – Long thin black cable – connect to rear right edge of the server board.
    - I<sup>2</sup>C cables are routed along the base of the right chassis sidewall.
  - 2-pin front panel sensor cable – Black and Red Wires – connect to front right edge of the server board.
  - Right Front I/O Panel cable – Long thick back cable – connect to back right edge of the server board into slot connector.
    - Cable is routed along the base of the right chassis sidewall.
  - Left front panel cable – Grey flat cable – connect to rear left edge of the server board.
3. Install the four plastic cable management brackets to the chassis sidewalls.
  - The brackets mount to studs on the sidewall.
  - Slide the brackets over the studs until they lock into place.
4. Install all memory modules and DIMM blanks (if present) (see [Section 3.4](#)).
  - See memory population rules in [Appendix B](#).
5. Install all processor heat sink modules (PHM) (see [Section 5.9.4](#)).
  - PHMs with black labels install to front processor sockets.
  - PHMs with white labels install to rear processor sockets.
6. (If present) Install TPM and Intel VROC key options to the server board.
7. (If present) Install Riser Card Assemblies (see [Section 3.2.3](#)).
  - (If present) Attach Aux PCIe cable(s) to the back side of the riser card. Then, route and attach the cable(s) to the nearest slim-PCIe connector(s) on the server board
8. (If present) Install PCIe add-in card(s) to the PCIe add-in slots on the server board (see [Section 3.2.1](#)).
  - (If present) Attach and route internal cables from PCIe add-in cards to destination connectors within the system.
9. Install the system fan housing and mounting brackets (see [Section 2.3.2.2](#)).
  - Ensure all cables being routed from / to the area behind the front drive bay are attached and routed before attaching the fan housing mounting brackets to the chassis sidewalls.
10. Install the power supply modules (see [Section 5.4](#)).
11. (If present) Install the OCP 3.0 small form factor add-in card (see [Section 3.5.1](#)).
12. Install the system air duct (see [Section 2.2.1](#)).
13. Install the system top cover (see [Section 2.2.2](#)).
14. Attach AC power cords from AC Power source to power supply modules.

During system POST (Power-On Self-Test), access the <F2> BIOS Setup Utility

1. Reset system Time and Date.
2. Ensure the system has the latest BIOS and BMC firmware installed.
  - If the installed System Software Stack is not the latest, download the latest System Update Package (SUP) and perform a system update.
3. Reset BIOS options to desired settings.

---

**Note:** If Intel® Optane™ PMem devices were re-installed, it may be necessary to unlock them for continued use and to retrieve any persistent data they may still have written on them. See the Intel® Optane™ PMem documentation for additional information.

---

## Appendix A. Getting Help

To obtain support for an issue with the server system, follow these steps:

1. Visit the following Intel support webpage: <http://www.intel.com/support/>

This webpage provides 24x7 support when you need it to get the latest and most complete technical support information on all Intel® Enterprise Server and Storage Platforms. Information available at the support site includes:

- Latest BIOS, firmware, drivers, and utilities
  - Product documentation, setup, and service guides
  - Full product specifications, technical advisories, and errata
  - Compatibility documentation for memory, hardware add-in cards, and operating systems
  - Server and chassis accessory parts list for ordering upgrades or spare parts
  - A searchable knowledge base to search for product information throughout the support site
2. If a solution cannot be found at Intel's support site, send an email to Intel's technical support center using the online form available at [http://www.intel.com/p/en\\_US/support/contactsupport](http://www.intel.com/p/en_US/support/contactsupport).
  3. Lastly, contact an Intel support representative using one of the support phone numbers available at <https://signin.intel.com/Contact> (charges may apply).

Intel also offers Channel Program members around-the-clock 24x7 technical phone support on Intel server boards, server chassis, server RAID controller cards, and Intel® Server Management at: <http://www.intel.com/reseller/>.

---

**Note:** Access to the 24x7 number requires a login to the reseller site.

---

### Warranty Information

To obtain warranty information, visit [http://www.intel.com/p/en\\_US/support/warranty](http://www.intel.com/p/en_US/support/warranty).



## Appendix B. Memory Population Rules

The Intel® Server System M70KLP supports up to 48 DDR4 DIMMs; 12 DIMM slots per processor.

Each processor supports six memory channels identified as 0 – 5. Each memory channel supports two DIMM slots identified as Slot 0 (White slots) and Slot 1 (Black slots).

On the server board, DIMM slots are identified by CPU #, Memory Channel #, and Slot #.

Examples: (CPU 0, Ch 0, Slot 0), (CPU 0, Ch 0, Slot 1), (CPU 0, Ch 1, Slot 0), etc.....

DIMM slots adjacent to their respective processor have the following layout on the server board.

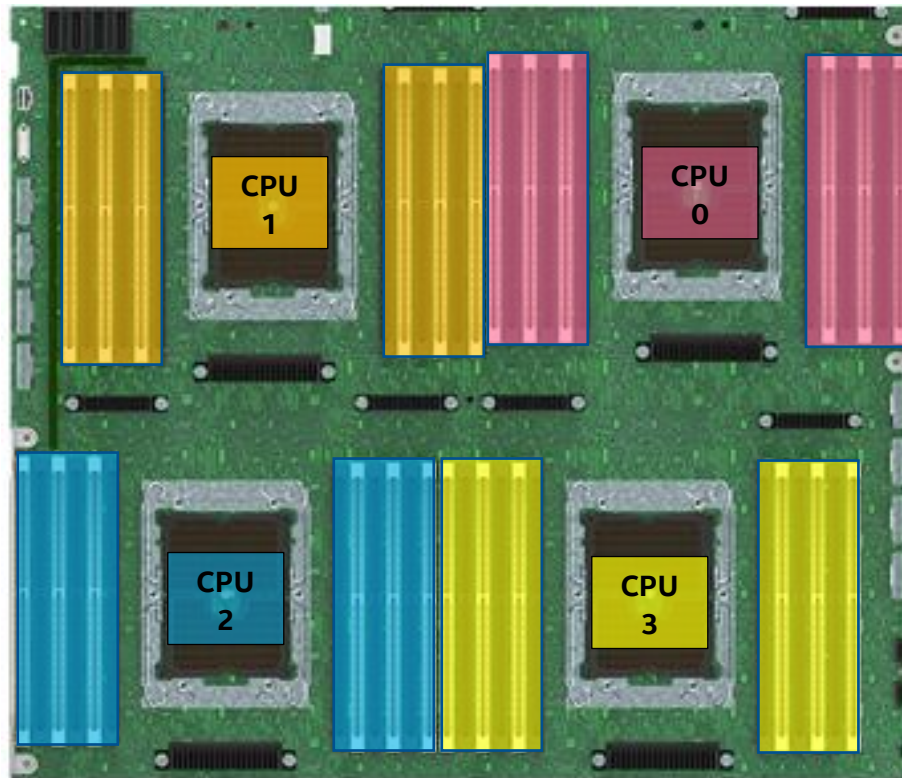
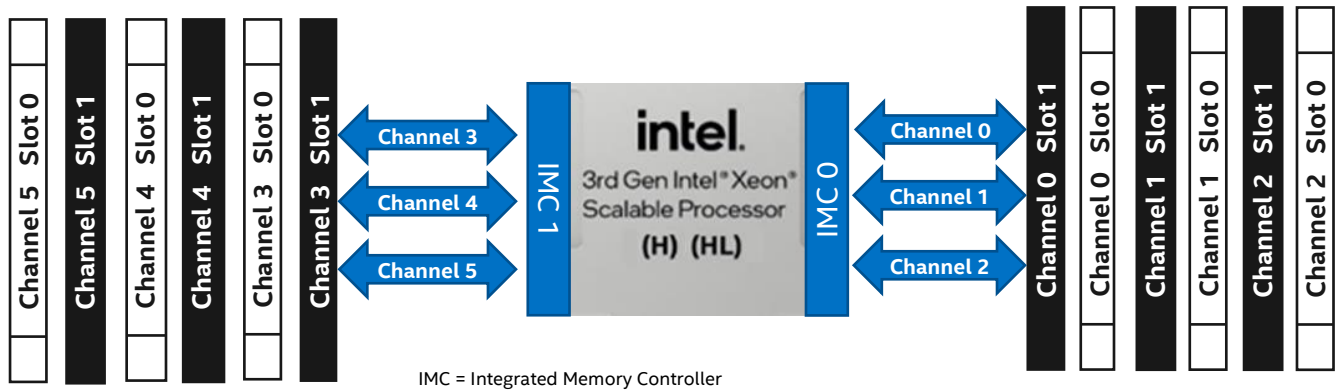


Figure 110. DIMM Slot Layout

The Intel® Server System M70KLP can support memory configurations that consists of only DDR4 SDRAM DIMMs or can support configurations consisting of both DDR4 SDRAM DIMMs and Intel® Optane™ persistent memory.

For additional information, download the *Intel® Server System M70KLP Technical Product Specification*.

## Intel DDR4 DIMM Support Disclaimer

Intel validates and will only provide support for system configurations where all installed DDR4 DIMMs have matching “Identical” or “Like” attributes. See [Table 4](#). A system configured concurrently with DDR4 DIMMs from different vendors will be supported by Intel if all other DDR4 “Like” DIMM attributes match.

Intel does not perform system validation testing nor will it provide support for system configurations where all populated DDR4 DIMMs do not have matching “Like” DIMM attributes as listed in [Table 4](#).

Intel will only provide support for Intel server systems configured with DDR4 DIMMs that have been validated by Intel and are listed on Intel’s Tested Memory list for the given Intel server product family.

Intel configures and ships pre-integrated L9 server systems. All DDR4 DIMMs within a given L9 server system as shipped by Intel will be identical. All installed DIMMs will have matching attributes as those listed in the “Identical” *DDR4 DIMM4 Attributes* column in [Table 4](#).

When purchasing more than one integrated L9 server system with the same configuration from Intel, Intel reserves the right to use “Like” DIMMs between server systems. At a minimum “Like” DIMMs will have matching DIMM attributes as listed in the table below. However, the DIMM model #, revision #, or vendor may be different.

For warranty replacement, Intel will make every effort to ship back an exact match to the one returned. However, Intel may ship back a validated “Like” DIMM. A “Like” DIMM may be from the same vendor but may not be the same revision # or model #, or it may be an Intel validated DIMM from a different vendor. At a minimum, all “Like” DIMMs shipped from Intel will match attributes of the original part according to the definition of “Like” DIMMs in the following table.

**Table 4. DDR4 DIMM Attributes Table for “Identical” and “Like” DIMMs**

<ul style="list-style-type: none"> <li>• DDR4 DIMMs are considered “Identical” when ALL listed attributes between the DIMMs match</li> <li>• Two or more DDR4 DIMMs are considered “Like” DIMMs when all attributes minus the Vendor, and/or DIMM Part # and/or DIMM Revision#, are the same.</li> </ul>			
Attribute	“Identical” DDR4 DIMM Attributes	“Like” DDR4 DIMM Attributes	Possible DDR4 Attribute Values
Vendor	<b>Match</b>	<b>Maybe Different</b>	Memory Vendor Name
DIMM Part #	<b>Match</b>	<b>Maybe Different</b>	Memory Vendor Part #
DIMM Revision #	<b>Match</b>	<b>Maybe Different</b>	Memory Vendor Part Revision #
DRAM Type	<b>Match</b>	<b>Match</b>	DDR4
DIMM Type	<b>Match</b>	<b>Match</b>	RDIMM, LRDIMM
Speed (MHz)	<b>Match</b>	<b>Match</b>	2666, 2933, 3200
Voltage	<b>Match</b>	<b>Match</b>	1.2V
DIMM Size (GB)	<b>Match</b>	<b>Match</b>	8GB, 16GB, 32GB, 64GB, 128GB, 256GB
Organization	<b>Match</b>	<b>Match</b>	1Gx72; 2Gx72; 4Gx72; 8Gx72; 16Gx72; 32Gx72
DIMM Rank	<b>Match</b>	<b>Match</b>	1R, 2R, 4R, 8R
DRAM Width	<b>Match</b>	<b>Match</b>	x4, x8
DRAM Density	<b>Match</b>	<b>Match</b>	8Gb, 16Gb

### DDR4 DRAM DIMM Population Rules

The following DDR4 SDRAM population rules apply for most reliable operation.

- Mixed DDR4 DIMM rules:

---

**Note:** Intel will only support mixed DDR4 DRAM DIMM configurations as defined in the *Intel DDR4 Support Disclaimer* above.

---

- Mixing DDR4 DIMMs of different speeds and latencies is not supported within or across processors. If a mixed configuration is encountered, the BIOS attempts to operate at the highest common speed and the lowest latency possible.
- x4 and x8 DDR4 DIMMs may be mixed in the same channel.
- Mixing of DDR4 DIMM types (RDIMM, LRDIMM, 3DS-RDIMM, 3DS-LRDIMM) within or across processors is not supported. This is a Fatal Error Halt in Memory Initialization.
- For a single DDR4 DIMM in a dual-slot channel, populate slot 0 (white slot).

Chan 5		Chan4		Chan 3		Chan 0		Chan 1		Chan 2	
Slot 0	Slot 1	Slot 0	Slot 1	Slot 0	Slot 1	Slot 1	Slot 0	Slot 1	Slot 0	Slot 1	Slot 0
DDR4		DDR4		DDR4			DDR4		DDR4		DDR4

- For multiple DDR4 DIMMs per channel:
  - For RDIMM, LRDIMM, 3DS-RDIMM, and 3DS-LRDIMM, always populate DIMMs with higher electrical loading in slot 0 (white slot).
  - When populating a quad-rank DDR4 DIMM with a single- or dual-rank DDR4 DIMM in the same channel, the quad-rank DDR4 DIMM must be populated farthest from the processor. Incorrect DIMM placement results in an MRC error code. A maximum of 8 logical ranks can be used on any one channel, as well as a maximum of 10 physical ranks loaded on a channel.
- Memory slots associated with a given processor socket cannot be used if no processor is installed within the socket.
- Processor sockets are self-contained and autonomous. However, all memory subsystem support (such as memory RAS and error management) in the BIOS Setup are applied commonly for each installed processor.
- For best system performance, memory must be installed in all six channels for each installed processor.
- For best performance, when NOT populating all memory channels, DDR4 DIMMs must be populated symmetrically between IMCs into memory slots on both sides of the CPU for each installed CPU
  - Example: when populating 4 DDR4 DIMMs to a given CPU, the DIMMs must be installed to memory channels 0, 1, 3, and 4 as shown below.

Chan 5		Chan4		Chan 3		Chan 0		Chan 1		Chan 2	
Slot 0	Slot 1	Slot 0	Slot 1	Slot 0	Slot 1	Slot 1	Slot 0	Slot 1	Slot 0	Slot 1	Slot 0
		DDR4		DDR4			DDR4		DDR4		

- For best system performance in a multi-processor configuration, the installed DDR4 DIMM population must be the same for each installed processor.

## Intel® Optane™ Persistent Memory 200 Series Population Rules

### All operating modes:

- Platform requires a maximum of 1 PMem module per memory channel and at least one PMem module per populated CPU.
- All populated CPUs within a platform must have an identical PMem population.
- Mixing PMem modules of different capacities anywhere on the platform, across or within same CPU socket, is NOT supported.
- When populating a memory channel with both a DDR4 DRAM DIMM and a PMem module, populate the PMem module into the Slot 1 (Black) memory slot.

Chan 5		Chan4		Chan 3		IMC1	CPU	IMC0	Chan 0		Chan 1		Chan 2	
Slot 0	Slot 1	Slot 0	Slot 1	Slot 0	Slot 1				Slot 1	Slot 0	Slot 1	Slot 0	Slot 1	Slot 1
DDR4	PMem	DDR4	PMem	DDR4	PMem				PMem	DDR4	PMem	DDR4	PMem	DDR4

- When populating a memory channel with only a PMem module, populate the Slot 0 (White) memory slot.
- When populating a single PMem module for each installed CPU, the PMem module must be installed into memory channel 0
- Mixing of different DDR4 DRAM DIMM types on the platform is not supported nor validated. Ensure all DDR4 and PMem capacity size and types across all CPUs on the platform are the same.

### Memory mode:

- Not Supported

### App direct mode:

- A minimum of one DDR4 DRAM DIMM per memory channel for each installed CPU.
- A minimum of one PMem module per system.
- When populating DDR4 DRAM + PMem, Intel recommends devices have a DDR4 DIMM capacity to PMem module capacity ratio of 1:1, 1:2, or 1:4

Examples:

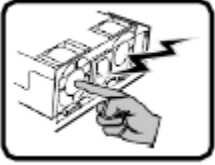
- 1:1 = 128 GB DRAM DIMM : 128 GB PMem Module
- 1:2 = 64 GB DRAM DIMM : 128 GB PMem Module
- 1:4 = 32 GB DRAM DIMM : 128GB PMem Module

- PMem modules must be populated symmetrically into memory slots on both sides of the CPU
  - Example: when populating 2 PMem modules to a given CPU, the PMem modules must be installed to memory channels 0 and 3 as shown below.

Chan 5		Chan4		Chan 3		IMC1	CPU	IMC0	Chan 0		Chan 1		Chan 2	
Slot 0	Slot 1	Slot 0	Slot 1	Slot 0	Slot 1				Slot 1	Slot 0	Slot 1	Slot 0	Slot 1	Slot 1
				DDR4	PMem				PMem	DDR4				

## Appendix C. Product Safety – Multi-Language

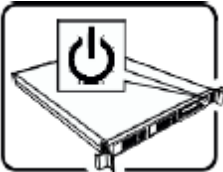
### WARNING: English (US)



The power supply in this product contains no user-serviceable parts. There may be more than one supply in this product. Refer servicing only to qualified personnel.



Do not attempt to modify or use the supplied AC power cord if it is not the exact type required. A product with more than one power supply will have a separate AC power cord for each supply.



The power button on the system does not turn off system AC power. To remove AC power from the system, you must unplug each AC power cord from the wall outlet or power supply.

The power cord(s) is considered the disconnect device to the main (AC) power. The socket outlet that the system plugs into shall be installed near the equipment and shall be easily accessible.



**SAFETY STEPS:** Whenever you remove the chassis covers to access the inside of the system, follow these steps:

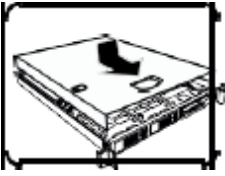
1. Turn off all peripheral devices connected to the system.
2. Turn off the system by pressing the power button.
3. Unplug all AC power cords from the system or from wall outlets.
4. Label and disconnect all cables connected to I/O connectors or ports on the back of the system.
5. Provide some electrostatic discharge (ESD) protection by wearing an antistatic wrist strap attached to chassis ground of the system—any unpainted metal surface—when handling components.
6. Do not operate the system with the chassis covers removed.



After you have completed the six SAFETY steps above, you can remove the system covers. To do this:

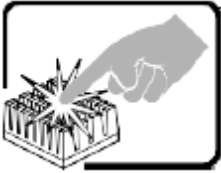
1. Unlock and remove the padlock from the back of the system if a padlock has been installed.
2. Remove and save all screws from the covers.
3. Remove the covers.





For proper cooling and airflow, always reinstall the chassis covers before turning on the system. Operating the system without the covers in place can damage system parts. To install the covers:

1. Check first to make sure you have not left loose tools or parts inside the system.
2. Check that cables, add-in boards, and other components are properly installed.
3. Attach the covers to the chassis with the screws removed earlier and tighten them firmly.
4. Insert and lock the padlock to the system to prevent unauthorized access inside the system.
5. Connect all external cables and the AC power cord(s) to the system.



A microprocessor and heat sink may be hot if the system has been running. Also, there may be sharp pins and edges on some board and chassis parts. Contact should be made with care. Consider wearing protective gloves.

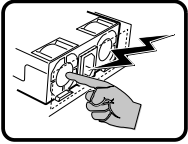


Danger of explosion if the battery is incorrectly replaced. Replace only with the same or equivalent type recommended by the equipment manufacturer. Dispose of used batteries according to manufacturer's instructions.

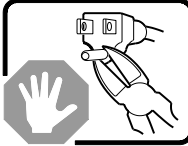


The system is designed to operate in a typical office environment. Choose a site that is:

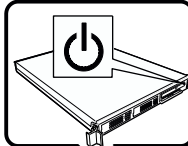
- Clean and free of airborne particles (other than normal room dust).
- Well ventilated and away from sources of heat including direct sunlight.
- Away from sources of vibration or physical shock.
- Isolated from strong electromagnetic fields produced by electrical devices.
- In regions that are susceptible to electrical storms, we recommend you plug your system into a surge suppresser and disconnect telecommunication lines to your modem during an electrical storm.
- Provided with a properly grounded wall outlet.
- Provided with sufficient space to access the power supply cord(s), because they serve as the product's main power disconnect.

**ОСТОРОЖНО: русский**

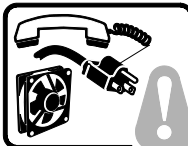
Блок питания данного изделия не содержит деталей, подлежащих обслуживанию пользователем. В этом изделии может быть несколько блоков питания. Обслуживание должно выполняться только квалифицированным персоналом.



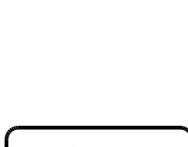
Не модифицируйте и не используйте прилагаемый кабель питания, если он не соответствует требуемому типу. Если в устройстве несколько блоков питания, то к каждому блоку питания прилагается отдельный кабель питания.



При нажатии кнопки питания не отключается питание системы от электросети. Чтобы отключить подачу питания переменного тока в систему, необходимо отсоединить все кабели питания от электрической розетки или блока питания.

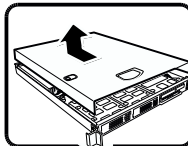


Кабель питания считается размыкателем питания переменного тока. Электрическая розетка, к которой подключается система, должна находиться рядом с оборудованием и быть легко доступной.



**ИНСТРУКЦИИ ПО ТЕХНИКЕ БЕЗОПАСНОСТИ.** Каждый раз перед снятием крышек корпуса для доступа к внутренней части системы выполняйте следующие действия:

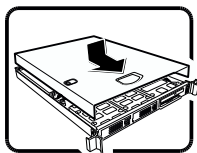
1. Выключите все периферийные устройства, подключенные к системе.
2. Выключите систему, нажав кнопку питания.
3. Отсоедините все кабели питания от системы или электрических розеток.
4. Промаркируйте и отсоедините все кабели, подключенные к разъемам или портам ввода/вывода на задней панели системы.
5. Для обеспечения защиты от электростатического разряда при работе с компонентами надевайте антистатический браслет, прикрепленный к заземленной части корпуса системы (любой неокрашенной металлической поверхности).
6. Запрещается работать с системой, когда крышки корпуса сняты.



Крышки корпуса системы можно снимать, когда выполнены все шесть описанных выше мер безопасности. Для этого:

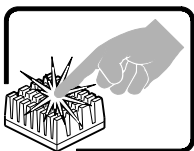
1. Откройте и снимите навесной замок (если имеется) с задней части системы.
2. Выверните все винты с крышек и сохраните их.
3. Снимите крышки.

(продолжение)

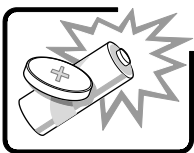
**ОСТОРОЖНО: русский** (продолжение)

Для обеспечения надлежащего охлаждения и воздушного потока всегда устанавливайте на место крышки корпуса перед включением системы. Работа системы без установленных крышек может привести к повреждению компонентов системы. Чтобы установить крышки, выполните следующие действия:

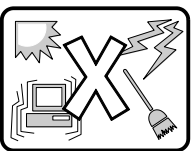
1. Сначала проверьте, не осталось ли в системе незакрепленных инструментов или деталей.
2. Убедитесь, что кабели, платы расширения и другие компоненты установлены правильно.
3. Закрепите крышки на корпусе, завернув и надежно затянув винты, снятые ранее.
4. Установите и закройте навесной замок для предотвращения несанкционированного доступа внутрь системы.
5. Подключите к системе все внешние кабели и кабели питания.



Микропроцессор и теплоотвод могут нагреваться во время работы системы. На некоторых деталях платы и корпуса могут быть острые выступы и кромки. Соблюдайте осторожность. Рекомендуется использовать защитные перчатки.



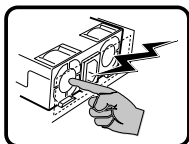
В случае неправильной замены аккумулятора существует опасность взрыва. При замене используйте только те же или эквивалентные модели аккумуляторов, рекомендованные производителем оборудования. Утилизируйте использованные аккумуляторы в соответствии с инструкциями производителя.



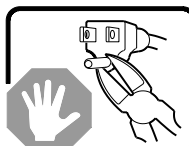
Система предназначена для работы в обычной офисной среде. Место установки системы должно соответствовать следующим требованиям:

- Помещение должно быть чистым, в воздухе не должно быть взвешенных частиц (кроме обычной пыли).
- Место установки должно хорошо вентилироваться и находиться вдали от источников тепла (включая прямой солнечный свет).
- Место установки должно находиться вдали от источников вибрации или механических ударов.
- Место установки должно быть изолировано от сильных электромагнитных полей, создаваемых электрическими устройствами.
- В регионах, где часто бывает гроза, рекомендуется подключать систему к сетевому фильтру и отключать телекоммуникационные линии от модема во время грозы.
- В помещении должна быть правильно заземленная электрическая розетка.
- Должен быть оставлен достаточный зазор для доступа к кабелям питания, которые служат размыкателем электропитания системы.

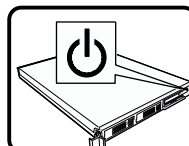
## УВАГА! Українська



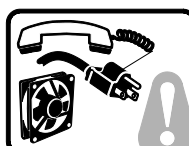
Джерело живлення в цьому виробі не містить жодних частин, які користувачі могли б обслуговувати самостійно. Цей виріб може містити більше одного джерела живлення. Обслуговувати його може виключно кваліфікований персонал.



Не намагайтеся модифікувати шнур живлення змінного струму з комплекту або користуватися ним, якщо він не відповідає потрібному типу. Виріб із джерелами живлення більше одного має окремі шнури живлення змінного струму для кожного джерела.



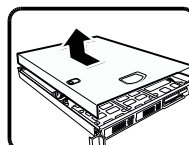
Кнопка живлення на системі не вимикає живлення змінного струму системи. Щоб позбавити систему змінного струму, слід вийняти всі шнури живлення змінного струму зі стінних розеток або джерел живлення.



Вважається, що шнур(и) живлення є пристроями вимкнення основного живлення (змінного струму). Розетка електромережі, до якої підключається система, мусить бути розташована поруч із обладнанням і легкодоступна.

**КРОКИ БЕЗПЕКИ:** Щоразу, знімаючи корпус для доступу до внутрішніх частин системи, виконуйте ці кроки:

7. Вимкніть усі периферійні пристрої, підключені до системи.
8. Вимкніть систему, натиснувши кнопку живлення.
9. Вийміть шнури живлення змінного струму із системи чи стінних розеток.
10. Позначте і від'єднайте всі кабелі, підключені до з'єднувачів входу/виходу або портів ззаду на системі.
11. Працюючи з компонентами, захищайтеся від електростатичних розрядів (ЕР), вдягаючи антистатичний ремінець-браслет, прикріплений до елемента заземлення корпусу - будь-якої непофарбованої металевої поверхні.
12. Не використовуйте систему з відкритим корпусом.

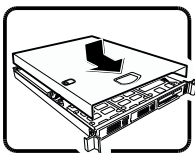


Після виконання шести наведених вище кроків БЕЗПЕКИ можна знімати корпус (кришки) з системи. Для цього виконайте такі дії:

4. Розблокуйте і зніміть замок ззаду на системі, якщо його встановлено.
5. Зніміть і збережіть всі гвинти з кришок.
6. Зніміть усі кришки.

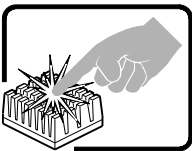
продовження

**УВАГА! Українська (продовження)**

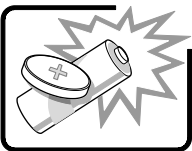


Для правильного охолодження та вентиляції завжди повертайте на місце кришки корпусу перед увімкненням системи. Робота системи без кришок може пошкодити деталі системи. Щоб установити кришки, виконайте такі дії:

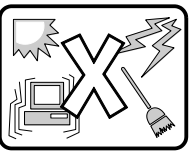
6. Спочатку переконайтеся, що всередині системи не залишилося деталей або незакріплених інструментів.
7. Перевірте, чи правильно встановлено кабелі, розширювальні плати та інші компоненти.
8. Прикріпіть кришки до корпусу знятими раніше гвинтами та надійно їх затягніть.
9. Вставте в систему і зафіксуйте замок, щоб запобігти неавторизованому доступу до нього.
10. Підключіть усі зовнішні кабелі та шнур(и) живлення змінного струму до системи.



Під час роботи системи мікропроцесор і радіатор можуть розігрітися до гарячого. Деякі частини корпусу і плат можуть мати гострі шипи або краї. Із ними слід поводитися обережно. Можна вдягти захисні рукавички.



Загроза вибуху, якщо батарею замінено на неправильну. Замінюйте лише таким самим або еквівалентним типом, рекомендованим виробником. Утилізуйте використані батареї згідно з інструкціями виробника.

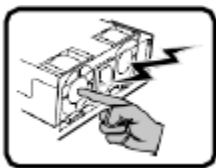


Систему створено для роботи в типовому офісному приміщенні. Виберіть місце, яке:

- Чисте і де немає в повітрі інших дрібних часточок, окрім звичайного побутового пилу.
- Добре провітрюється, розташоване далеко від джерел тепла, включно з прямим сонячним промінням.
- Розташоване далеко від джерел вібрації і струсів.
- Ізольоване від сильних електромагнітних полів, спричинених електроприладами.
- У регіонах, де часто проходять грози, радимо підключати пристрій через пристрій захисту від викидів напруги та відключити телекомунікаційні лінії від модему під час грози.
- Оснащене правильно заземленими стінними розетками електромережі.
- Має достатньо простору для доступу до шнура(ів) живлення, оскільки вони слугують основними вимикачами виробу.



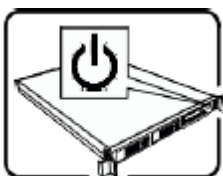
## AVERTISSEMENT: Français



Le bloc d'alimentation de ce produit ne contient aucune pièce pouvant être réparée par l'utilisateur. Ce produit peut contenir plus d'un bloc d'alimentation. Veuillez contacter un technicien qualifié en cas de problème.



Ne pas essayer d'utiliser ni modifier le câble d'alimentation CA fourni, s'il ne correspond pas exactement au type requis. Le nombre de câbles d'alimentation CA fournis correspond au nombre de blocs d'alimentation du produit.

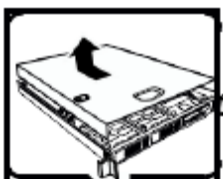


Notez que le commutateur CC de mise sous tension /hors tension du panneau avant n'éteint pas l'alimentation CA du système. Pour mettre le système hors tension, vous devez débrancher chaque câble d'alimentation de sa prise.



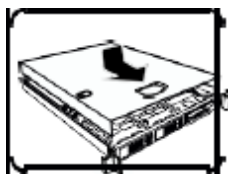
**CONSIGNES DE SÉCURITÉ:** Lorsque vous ouvrez le boîtier pour accéder à l'intérieur du système, suivez les consignes suivantes:

1. Mettez hors tension tous les périphériques connectés au système.
2. Mettez le système hors tension en mettant l'interrupteur général en position OFF (bouton-poussoir).
3. Débranchez tous les cordons d'alimentation c.a. du système et des prises murales.
4. Identifiez et débranchez tous les câbles reliés aux connecteurs d'E-S ou aux accès derrière le système.
5. Pour prévenir les décharges électrostatiques lorsque vous touchez aux composants, portez une bande antistatique pour poignet et reliez-la à la masse du système (toute surface métallique non peinte du boîtier).
6. Ne faites pas fonctionner le système tandis que le boîtier est ouvert.



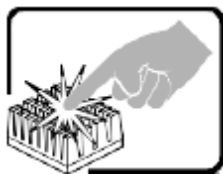
Une fois TOUTES les étapes précédentes accomplies, vous pouvez retirer les panneaux du système. Procédez comme suit:

1. Si un cadenas a été installé sur à l'arrière du système, déverrouillez-le et retirez-le.
2. Retirez toutes les vis des panneaux et mettez-les dans un endroit sûr.
3. Retirez les panneaux.



Afin de permettre le refroidissement et l'aération du système, réinstallez toujours les panneaux du boîtier avant de mettre le système sous tension. Le fonctionnement du système en l'absence des panneaux risque d'endommager ses pièces. Pour installer les panneaux, procédez comme suit:

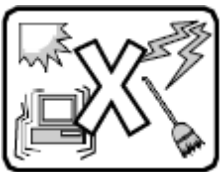
1. Assurez-vous de ne pas avoir oublié d'outils ou de pièces démontées dans le système.
2. Assurez-vous que les câbles, les cartes d'extension et les autres composants sont bien installés.
3. Revissez solidement les panneaux du boîtier avec les vis retirées plus tôt.
4. Remettez le cadenas en place et verrouillez-le afin de prévenir tout accès non autorisé à l'intérieur du système.
5. Rebranchez tous les cordons d'alimentation c. a. et câbles externes au système.



Le microprocesseur et le dissipateur de chaleur peuvent être chauds si le système a été sous tension. Faites également attention aux broches aiguës des cartes et aux bords tranchants du capot. Nous vous recommandons l'usage de gants de protection.

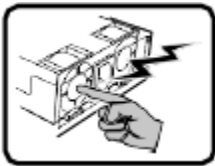


Danger d'explosion si la batterie n'est pas remontée correctement. Remplacer uniquement avec une batterie du même type ou d'un type équivalent recommandé par le fabricant. Disposez des piles usées selon les instructions du fabricant.

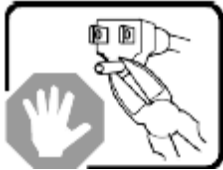


Le système a été conçu pour fonctionner dans un cadre de travail normal. L'emplacement choisi doit être:

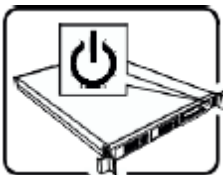
- Propre et dépourvu de poussière en suspension (sauf la poussière normale).
- Bien aéré et loin des sources de chaleur, y compris du soleil direct.
- A l'abri des chocs et des sources de vibrations.
- Isolé de forts champs électromagnétiques générés par des appareils électriques.
- Dans les régions sujettes aux orages magnétiques il est recommandé de brancher votre système à un suppresseur de surtension, et de débrancher toutes les lignes de télécommunications de votre modem durant un orage.
- Muni d'une prise murale correctement mise à la terre.
- Suffisamment spacieux pour vous permettre d'accéder aux câbles d'alimentation (ceux-ci étant le seul moyen de mettre le système hors tension).

**WARNUNG: Deutsch**

Benutzer können am Netzgerät dieses Produkts keine Reparaturen vornehmen. Das Produkt enthält möglicherweise mehrere Netzgeräte. Wartungsarbeiten müssen von qualifizierten Technikern ausgeführt werden.



Versuchen Sie nicht, das mitgelieferte Netzkabel zu ändern oder zu verwenden, wenn es sich nicht genau um den erforderlichen Typ handelt. Ein Produkt mit mehreren Netzgeräten hat für jedes Netzgerät ein eigenes Netzkabel.



Der Wechselstrom des Systems wird durch den Ein-/Aus-Schalter für Gleichstrom nicht ausgeschaltet. Ziehen Sie jedes Wechselstrom-Netzkabel aus der Steckdose bzw. dem Netzgerät, um den Stromanschluß des Systems zu unterbrechen.



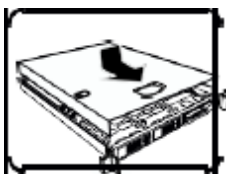
**SICHERHEISSCHRIFFEN:** Immer wenn Sie die Gehäuseabdeckung abnehmen um an das Systeminnere zu gelangen, sollten Sie folgende Schritte beachten:

1. Schalten Sie alle an Ihr System angeschlossenen Peripheriegeräte aus.
2. Schalten Sie das System mit dem Hauptschalter aus.
3. Ziehen Sie den Stromanschlußstecker Ihres Systems aus der Steckdose.
4. Auf der Rückseite des Systems beschriften und ziehen Sie alle Anschlußkabel von den I/O Anschlüssen oder Ports ab.
5. Tragen Sie ein geerdetes Antistatik Gelenkband, um elektrostatische Ladungen (ESD) über blanke Metallstellen bei der Handhabung der Komponenten zu vermeiden.
6. Schalten Sie das System niemals ohne ordnungsgemäß montiertes Gehäuse ein.



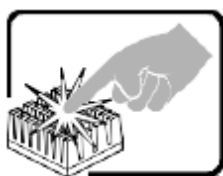
Nachdem Sie die oben erwähnten ersten sechs SICHERHEITSSCHRITTE durchgeführt haben, können Sie die Abdeckung abnehmen, indem Sie:

1. Öffnen und entfernen Sie die Verschlusseinrichtung (Padlock) auf der Rückseite des Systems, falls eine Verschlusseinrichtung installiert ist.
2. Entfernen Sie alle Schrauben der Gehäuseabdeckung.
3. Nehmen Sie die Abdeckung ab.



Zur ordnungsgemäßen Kühlung und Lüftung muß die Gehäuseabdeckung immer wieder vor dem Einschalten installiert werden. Ein Betrieb des Systems ohne angebrachte Abdeckung kann Ihrem System oder Teile darin beschädigen. Um die Abdeckung wieder anzubringen:

1. Vergewissern Sie sich, daß Sie keine Werkzeuge oder Teile im Innern des Systems zurückgelassen haben.
2. Überprüfen Sie alle Kabel, Zusatzkarten und andere Komponenten auf ordnungsgemäßen Sitz und Installation.
3. Bringen Sie die Abdeckungen wieder am Gehäuse an, indem Sie die zuvor gelösten Schrauben wieder anbringen. Ziehen Sie diese gut an.
4. Bringen Sie die Verschlusseinrichtung (Padlock) wieder an und schließen Sie diese, um ein unerlaubtes Öffnen des Systems zu verhindern.
5. Schließen Sie alle externen Kabel und den AC Stromanschlußstecker Ihres Systems wieder an.



Der Mikroprozessor und der Kühler sind möglicherweise erhitzt, wenn das System in Betrieb ist. Außerdem können einige Platinen und Gehäuseteile scharfe Spitzen und Kanten aufweisen. Arbeiten an Platinen und Gehäuse sollten vorsichtig ausgeführt werden. Sie sollten Schutzhandschuhe tragen.

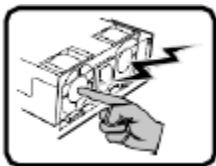


Bei falschem Einsetzen einer neuen Batterie besteht Explosionsgefahr. Die Batterie darf nur durch denselben oder einen entsprechenden, vom Hersteller empfohlenen Batterietyp ersetzt werden. Entsorgen Sie verbrauchte Batterien den Anweisungen des Herstellers entsprechend.



Das System wurde für den Betrieb in einer normalen Büroumgebung entwickelt. Der Standort sollte:

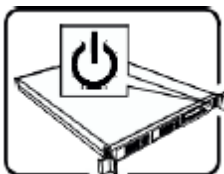
- sauber und staubfrei sein (Hausstaub ausgenommen);
- gut gelüftet und keinen Heizquellen ausgesetzt sein (einschließlich direkter Sonneneinstrahlung);
- keinen Erschütterungen ausgesetzt sein;
- keine starken, von elektrischen Geräten erzeugten elektromagnetischen Felder aufweisen;
- in Regionen, in denen elektrische Stürme auftreten, mit einem Überspannungsschutzgerät verbunden sein; während eines elektrischen Sturms sollte keine Verbindung der Telekommunikationsleitungen mit dem Modem bestehen;
- mit einer geerdeten Wechselstromsteckdose ausgerüstet sein;
- über ausreichend Platz verfügen, um Zugang zu den Netzkabeln zu gewährleisten, da der Stromanschluß des Produkts hauptsächlich über die Kabel unterbrochen wird.

**AVVERTENZA: Italiano**

Rivolgersi ad un tecnico specializzato per la riparazione dei componenti dell'alimentazione di questo prodotto. È possibile che il prodotto disponga di più fonti di alimentazione.



Non modificare o utilizzare il cavo di alimentazione in c.a. fornito dal produttore, se non corrisponde esattamente al tipo richiesto. Ad ogni fonte di alimentazione corrisponde un cavo di alimentazione in c.a. separato.

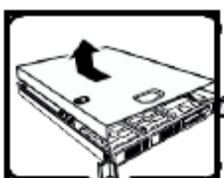


L'interruttore attivato/disattivato nel pannello anteriore non interrompe l'alimentazione in c.a. del sistema. Per interromperla, è necessario scollegare tutti i cavi di alimentazione in c.a. dalle prese a muro o dall'alimentazione di corrente.



**PASSI DI SICUREZZA:** Qualora si rimuovano le coperture del telaio per accedere all'interno del sistema, seguire i seguenti passi:

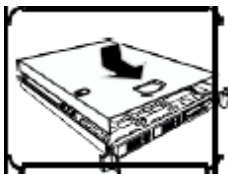
1. Spegnerne tutti i dispositivi periferici collegati al sistema.
2. Spegnerne il sistema, usando il pulsante spento/acceso dell'interruttore del sistema.
3. Togliere tutte le spine dei cavi del sistema dalle prese elettriche.
4. Identificare e sconnettere tutti i cavi attaccati ai collegamenti I/O od alle prese installate sul retro del sistema.
5. Qualora si tocchino i componenti, proteggersi dallo scarico elettrostatico (SES), portando un cinghia anti-statica da polso che è attaccata alla presa a terra del telaio del sistema – qualsiasi superficie non dipinta – .
6. Non far operare il sistema quando il telaio è senza le coperture.



Dopo aver seguito i sei passi di SICUREZZA sopracitati, togliere le coperture del telaio del sistema come segue:

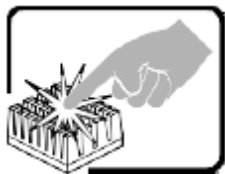
1. Aprire e rimuovere il lucchetto dal retro del sistema qualora ve ne fosse uno installato.
2. Togliere e mettere in un posto sicuro tutte le viti delle coperture.
3. Togliere le coperture.





Per il giusto flusso dell'aria e raffreddamento del sistema, rimettere sempre le coperture del telaio prima di riaccendere il sistema. Operare il sistema senza le coperture al loro proprio posto potrebbe danneggiare i componenti del sistema. Per rimettere le coperture del telaio:

1. Controllare prima che non si siano lasciati degli attrezzi o dei componenti dentro il sistema.
2. Controllare che i cavi, dei supporti aggiuntivi ed altri componenti siano stati installati appropriatamente.
3. Attaccare le coperture al telaio con le viti tolte in precedenza e avvitarle strettamente.
4. Inserire e chiudere a chiave il lucchetto sul retro del sistema per impedire l'accesso non autorizzato al sistema.
5. Ricollegare tutti i cavi esterni e le prolunghe AC del sistema.



Se il sistema è stato a lungo in funzione, il microprocessore e il dissipatore di calore potrebbero essere surriscaldati. Fare attenzione alla presenza di piedini appuntiti e parti taglienti sulle schede e sul telaio. È consigliabile l'uso di guanti di protezione.



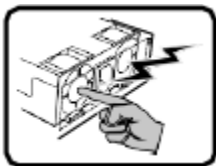
Esiste il pericolo di un'esplosione se la pila non viene sostituita in modo corretto. Utilizzare solo pile uguali o di tipo equivalente a quelle consigliate dal produttore. Per disfarsi delle pile usate, seguire le istruzioni del produttore.



Il sistema è progettato per funzionare in un ambiente di lavoro tipo. Scegliere una postazione che sia:

- Pulita e libera da particelle in sospensione (a parte la normale polvere presente nell'ambiente).
- Ben ventilata e lontana da fonti di calore, compresa la luce solare diretta.
- Al riparo da urti e lontana da fonti di vibrazione.
- Isolata dai forti campi magnetici prodotti da dispositivi elettrici.
- In aree soggette a temporali, è consigliabile collegare il sistema ad un limitatore di corrente. In caso di temporali, scollegare le linee di comunicazione dal modem.
- Dotata di una presa a muro correttamente installata.
- Dotata di spazio sufficiente ad accedere ai cavi di alimentazione, i quali rappresentano il mezzo principale di scollegamento del sistema.

## ADVERTENCIAS: Español

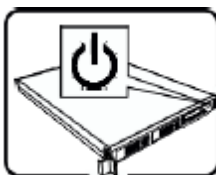


El usuario debe abstenerse de manipular los componentes de la fuente de alimentación de este producto, cuya reparación debe dejarse exclusivamente en manos de personal técnico especializado. Puede que este producto disponga de más de una fuente de alimentación.



No intente modificar ni usar el cable de alimentación de corriente alterna, si no corresponde exactamente con el tipo requerido.

El número de cables suministrados se corresponden con el número de fuentes de alimentación de corriente alterna que tenga el producto.

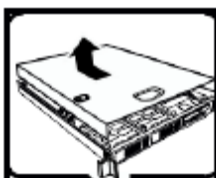


Nótese que el interruptor activado/desactivado en el panel frontal no desconecta la corriente alterna del sistema. Para desconectarla, deberá desenchufar todos los cables de corriente alterna de la pared o desconectar la fuente de alimentación.



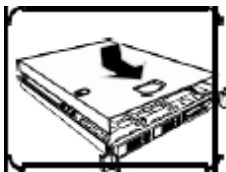
**INSTRUCCIONES DE SEGURIDAD:** Cuando extraiga la tapa del chasis para acceder al interior del sistema, siga las siguientes instrucciones:

1. Apague todos los dispositivos periféricos conectados al sistema.
2. Apague el sistema presionando el interruptor encendido/apagado.
3. Desconecte todos los cables de alimentación CA del sistema o de las tomas de corriente alterna.
4. Identifique y desconecte todos los cables enchufados a los conectores E/S o a los puertos situados en la parte posterior del sistema.
5. Cuando manipule los componentes, es importante protegerse contra la descarga electrostática (ESD). Puede hacerlo si utiliza una muñequera antiestática sujeta a la toma de tierra del chasis — o a cualquier tipo de superficie de metal sin pintar.
6. No ponga en marcha el sistema si se han extraído las tapas del chasis.



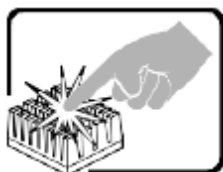
Después de completar las seis instrucciones de SEGURIDAD mencionadas, ya puede extraer las tapas del sistema. Para ello:

1. Desbloquee y extraiga el bloqueo de seguridad de la parte posterior del sistema, si se ha instalado uno.
2. Extraiga y guarde todos los tornillos de las tapas.
3. Extraiga las tapas.



Para obtener un enfriamiento y un flujo de aire adecuados, reinstale siempre las tapas del chasis antes de poner en marcha el sistema. Si pone en funcionamiento el sistema sin las tapas bien colocadas puede dañar los componentes del sistema. Para instalar las tapas:

1. Asegúrese primero de no haber dejado herramientas o componentes sueltos dentro del sistema.
2. Compruebe que los cables, las placas adicionales y otros componentes se hayan instalado correctamente.
3. Incorpore las tapas al chasis mediante los tornillos extraídos anteriormente, tensándolos firmemente.
4. Inserte el bloqueo de seguridad en el sistema y bloquéelo para impedir que pueda accederse al mismo sin autorización.
5. Conecte todos los cables externos y los cables de alimentación CA al sistema.



Si el sistema ha estado en funcionamiento, el microprocesador y el disipador de calor pueden estar aún calientes. También conviene tener en cuenta que en el chasis o en el tablero puede haber piezas cortantes o punzantes. Por ello, se recomienda precaución y el uso de guantes protectores.



Existe peligro de explosión si la pila no se cambia de forma adecuada. Utilice solamente pilas iguales o del mismo tipo que las recomendadas por el fabricante del equipo. Para deshacerse de las pilas usadas, siga igualmente las instrucciones del fabricante.

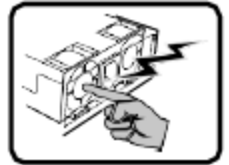


El sistema está diseñado para funcionar en un entorno de trabajo normal. Escoja un lugar:

- Limpio y libre de partículas en suspensión (salvo el polvo normal).
- Bien ventilado y alejado de fuentes de calor, incluida la luz solar directa.
- Alejado de fuentes de vibración.
- Aislado de campos electromagnéticos fuertes producidos por dispositivos eléctricos.
- En regiones con frecuentes tormentas eléctricas, se recomienda conectar su sistema a un eliminador de sobrevoltage y desconectar el módem de las líneas de telecomunicación durante las tormentas.
- Provisto de una toma de tierra correctamente instalada.
- Provisto de espacio suficiente como para acceder a los cables de alimentación, ya que éstos hacen de medio principal de desconexión del sistema.

**אזהרה: עברית**

אספקת החשמל במוצר זה לא מכילה חלקים שניתנים לשירות על ידי משתמש. ייתכן שיש יותר ממקור אספקת חשמל אחד במוצר זה. לקבלת שירות יש לפנות רק אל אנשים המוסמכים לכך.

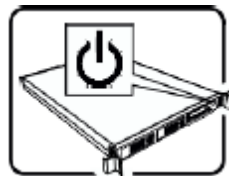


אין לנסות לשנות את כבל החשמל ז"ח המסופק, או לשנותו, אם הוא לא מהסוג המדויק הנדרש. למוצר עם יותר ממקור אספקת חשמל אחד יצורף כבל חשמל נפרד לכל מקור אספקת חשמל.



מתג ההפעלה במערכת לא מכבה את מערכת חשמל ז"ח. להסרת חשמל ז"ח מהמערכת, יש לנתק כל כבל חשמל ז"ח משקע הקיר או מאספקת החשמל.

כבל(ים) החשמל נחשב(ים) להתקן(ני) ניתוק מקור אספקת חשמל ז"ח. שקע הקיר שאליו מחוברת המערכת יותקן בסמוך לציוד ויהיה נגיש בקלות.



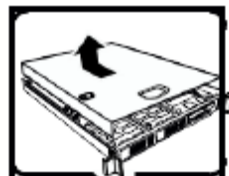
שלבי בטיחות: בכל פעם שמסירים את מכסי המעטפת כדי לגשת לחלק הפנימי של המערכת, יש לבצע את הצעדים הבאים:

1. לכבות את כל ההתקנים ההיקפיים שמחוברים למערכת.
2. לכבות את המערכת על ידי לחיצה על מתג ההפעלה.
3. לנתק את כל כבלי חשמל ז"ח מהמערכת או משקעי הקיר.
4. לתייג את כל הכבלים המחוברים למחברי קלט/פלט או ליציאות בגב המערכת ולנתק אותם.
5. לספק הגנה מסוימת מפריקות אלקטרוסטטיות (ESD) על ידי חבישת רצועת שורש כף יד אנטיסטטית שמחוברת להארקת המעטפת של המערכת - כל משטח מתכת לא צבוע - בעת הטיפול ברכיבים.
6. אין להפעיל את המערכת כשמכסי המעטפת מוסרים.

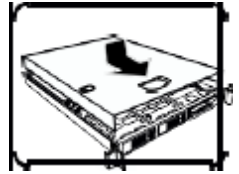


לאחר השלמת ששת שלבי הבטיחות לעיל, באפשרותכם להסיר את מכסי המערכת. כדי לעשות זאת:

1. יש לפתוח את המנעול התלוי ולהסירו מגב המערכת אם אכן הותקן בה מנעול תלוי.
2. יש להסיר את כל הברגים של המכסים ולשמור אותם.
3. יש להסיר את המכסים.

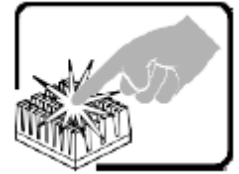


לקירור ולזרימת אוויר תקינים, יש תמיד להתקין מחדש את מכסי המעטפת לפני הפעלת המערכת. הפעלת המערכת ללא המכסים במקומם, עלולה לגרום נזק לחלקי המערכת. להתקנת המכסים:



1. יש לבדוק תחילה כדי לוודא שלא נשארו כלים או חלקים רופפים בתוך המערכת.
2. יש לבדוק שהכבלים, הלוחות הנוספים ורכיבים אחרים מותקנים כראוי.
3. יש לחבר את המכסים למעטפת עם הברגים שהוסרו קודם לכן ולהדק אותם בחוזקה למקומם.
4. יש להכניס את מנעול התליה למערכת ולנעול אותו כדי למנוע גישה בלתי מורשית לפנים המערכת.
5. יש לחבר את כל הכבלים החיצוניים ואת כבל(\*) חשמל ז"ח למערכת.

מעבד המיקרו ומפזר החום עלולים להיות לוחטים כשהמערכת פועלת. כמו כן, ייתכנו סיכות וקצוות חדים בחלקי לוח ומעטפת שונים. יש לגעת בזהירות. יש לשקול עטיית כפפות מגן.



סכנת פיצוץ אם הסוללה מוחלפת באופן שגוי. יש להחליף רק באותו סוג או שווה ערך שמומלץ על ידי יצרן הציוד. יש להשליך סוללות משומשות על פי הוראות היצרן.



המערכת נועדה לפעול בסביבה משרדית טיפוסית. יש לבחור אתר שהוא:

- נקי וחופשי מחלקיקים נישאים באוויר (למעט אבק שקיים באופן רגיל בחדר).
- מאוורר היטב ורחוק ממקורות חום כולל אור שמש ישיר.
- יש להרחיק ממקורות רטט או זעזועים פיזיים.
- מבודד משדות אלקטרומגנטיים חזקים שנגרמים על ידי מכשירים חשמליים.
- באזורים שרגישים לסערות חשמל, אנו ממליצים לחבר את המערכת למדכא נחשול, ובמהלך סערה חשמלית לנתק קווי תקשורת שמחוברים למודם שלכם.
- בעל שקע קיר מוארק כהלכה.
- בעל מספיק מקום לגישה חופשית לכבל(\*) החשמל, מכיוון שהוא/הם משמש(ים) לניתוק רשת החשמל למוצר.





## Appendix D. Glossary

Term	Definition
ACPI	Advanced Configuration and Power Interface
AIC	Add-In Card
ASHRAE	American Society of Heating, Refrigerating and Air-Conditioning Engineers
BBS	BIOS Boot Specification
BMC	Baseboard Management Controller
BIOS	Basic Input/Output System
CMOS	Complementary Metal-oxide-semiconductor
CPU	Central Processing Unit
DDR4	Double Data Rate 4th edition
DIMM	Dual In-line Memory Module
DPC	DIMMs per Channel
FP	Front Panel
FRB	Fault Resilient Boot
FRU	Field Replaceable Unit
GPGPU	General Purpose Graphic Processing Unit
GPIO	General Purpose Input/Output
GUI	Graphical User Interface
I <sup>2</sup> C	Inter-integrated Circuit bus
IMC	Integrated Memory Controller
IIO	Integrated Input/Output
iPC	Intel Product Code
IPMI	Intelligent Platform Management Interface
ISTA	International Safe Transit Association
LED	Light Emitting Diode
LFM	Linear Feet per Minute – Airflow measurement
LPC	Low-pin Count
LRDIMM	Load Reduced DIMM
LSB	Least Significant Bit
MSB	Most Significant Bit
MRC	Memory Reference Code
MTBF	Mean Time Between Failure
NAT	Network Address Translation
NMI	Non-maskable Interrupt
NTB	Non-Transparent Bridge
OEM	Original Equipment Manufacturer
OCP*	Open Compute Project*
OR	Oct Rank
PCH	Peripheral Controller Hub
PCI	Peripheral Component Interconnect
PCB	Printed Circuit Board
PCIe*	Peripheral Component Interconnect Express*
PCI-X	Peripheral Component Interconnect Extended
PDB	Power Distribution Board
PHM	Processor Heat sink Module

Term	Definition
<b>PMBus</b>	Power Management Bus
<b>PMM</b>	Persistent Memory Module
<b>POST</b>	Power-on Self-Test
<b>PSU</b>	Power Supply Unit
<b>QR</b>	Quad Rank
<b>RAID</b>	Redundant Array of Independent Disks
<b>RAM</b>	Random Access Memory
<b>RDIMM</b>	Registered DIMM
<b>RMFBU</b>	RAID Maintenance Free Backup Unit
<b>ROC</b>	RAID On Chip
<b>SAS</b>	Serial Attached SCSI
<b>SATA</b>	Serial Advanced Technology Attachment
<b>SEL</b>	System Event Log
<b>SCA</b>	Single Connector Attachment
<b>SCSI</b>	Small Computer System Interface
<b>SDR</b>	Sensor Data Record
<b>SFF</b>	Small Form Factor
<b>SMBus</b>	System Management Bus
<b>SR</b>	Single Rank
<b>SSD</b>	Solid State Device
<b>TDP</b>	Thermal Design Power